



**ROBBE & BERKING**  
SILBER

Price List – Cutlery · Table Accessories · Gift Items  
Liste de prix de vente – Couverts · Accessoires de table · Cadeaux  
Lista de precios – Cuberterías · Objetos de mesa · Artículos de regalo  
Prijslijst Bestekken · Tafelaccessoires · Geschenken  
Listino prezzi – Posate · Accessori Tavola · Articoli da regalo

1.3.2023



# Content | Index | Contenido | Index | Indice

	Page
Silver and massive silver plated cutlery   Couverts argent massif et argentés Cuberterías de plata y con baño de plata   Zilveren en verzilverde bestekken Posate d'argento e in lega argentate	4 – 7
Shape and size of individual pieces La forme et la taille des pièces individuelles   Forma y tamaño de las piezas Vorm en afmetingen van individuele delen   Forma e misura dei singoli pezzi	8 – 11
Gilding   Dorure   Baño   Verguld   Doratura	12
Repairs   Réparations   Reparaciones   Reparaties   Riparazioni	13
Sets   Garnitures   Adornos   Sets   Servizi	14
Table napkin rings   Ronds de serviette   Servilleteros   Servetringen   Portatovaglioli	15
Children's sets   Couverts pour enfants   Cubiertos infantiles   Kindercouverts Posate per bambini	16
Gourmet collection   Collection gourmet Colección gourmet   Gourmet collectie   Collezione gourmet	17
Stainless steel cutlery   Couverts acier massif Cuberterías acero inoxidable   Edelstalen bestekken   Posate Inox 18/8	18 – 19
Silver care products   Entretien et entreposage d'argenterie Cuidado y conservación de plata   Zilveronderhoud en opbergmogelijkheid Prodotti per la manutenzione di oggetti in argento	20 – 21
Bar Collection   Bar Collection   Colección del bar   Bar collectie   Collezione da bar	22 – 27
Bar trolley   Chariot de bar   Carro de bar   Bar trolley   Carrello bar	28
Bar trunk   Malle armoire de bar   Maleta bar   Koffer bar   Valigia da bar	29
The Box   Champagne Box	30
Barbecue collection   Barbecue collection   Colección Barbacoa Barbecue collectie   Collezione barbecue	31
Table accessories and gift items   Accessoires de table et cadeaux Objetos de mesa/Artículos de regalo   Tafelaccessoires/Geschenken Acessori tavola/Articoli da regalo	32 – 57
Service plates and trays   Assiettes et plateaux   Platos y bandejas Borden   Piatti e vassoi	58
Chess   échecs   el ajedrez   schaak   gli scacchi	59
X-mas/Easter decoration   Décoration arbre Noël/Pâque Decoraciones de Navidad/Pascua   Kerstversiering/decoratie van pasen Decorazioni natalizie/pasquali	60
Engravings   Gravures   Grabados   Gravures   Incisioni	61
Customised knife blades   Lames de couteau personnalisées Hojas de cuchillo personalizadas   Geïndividualiseerde mesbladen Lame di coltello personalizzate	62

All dimensions and weights in this price list are approximate and for guidance only.  
Minor deviations are possible and due to manufacture.

Toutes les dimensions et poids indiqués dans cette liste de prix sont approximatifs et ne sont donnés qu'à titre indicatif.  
Des écarts mineurs sont possibles en raison de la manufacture.

Todos los pesos y medidas en esta lista de precios son solamente datos aproximados y sirven únicamente como guía.  
Tolerancias pequeñas son relacionadas a la producción.

Alle in deze prijslijst vermelde maten en gewichten zijn circa-opgaven en dienen uitsluitend als leidraad.  
Kleine afwijkingen zijn productie gerelateerd mogelijk.

Tutte le dimensioni e i pesi citati in questo listino prezzi sono approssimativi e servono solo come guida.  
Deviazioni minori sono possibili a causa del processo di fabbricazione.

EN SILVER AND MASSIVE SILVER PLATED CUTLERY FR COUVERTS ARGENT MASSIF ET ARGENTÉS				072	050	053	045	040	019	056	060	044	068	057											
Composition of sets (p. 14)		925 Sterling Silver	150 massive silver plated	12	Alta	Alt-Chippendale*	Alt-Faden	Alt-Kopenhagen	Alt-Spaten	Arcade*	Art Deco*	Avenue*	Belvedere*	Classic-Faden*											
Art. No.   Art. Nr.																									
4	Piece set   Service à menu	1.004,-	388,-												●	●	●	●	●	●	●	●	●	●	●
9	Serving pieces   Pièces pour servir	4.321,-	1.603,-												●	●	●	●	●	●	●	●	●	●	●
24	Piece set   Service à menu	6.024,-	2.328,-												●	●	●	●	●	●	●	●	●	●	●
30	Piece set   Service à menu	7.110,-	2.796,-												●	●	●	●	●	●	●	●	●	●	●
39	Piece set   Service à menu	11.431,-	4.399,-												●	●	●	●	●	●	●	●	●	●	●
69	Piece set   Service à menu	18.541,-	7.195,-												●	●	●	●	●	●	●	●	●	●	●
69 NL	Piece set   Service à menu	18.892,-	7.474,-												●	●	●	●	●	●	●	●	●	●	●
75	Piece set   Service à menu	20.745,-	8.125,-												●	●	●	●	●	●	●	●	●	●	●
110	Piece set   Service à menu	30.548,-	11.321,-												●	●	●	●	●	●	●	●	●	●	●
128	Piece set   Service à menu	36.653,-	13.738,-												●	●	●	●	●	●	●	●	●	●	●
133	Piece set   Service à menu	37.878,-	14.281,-												●	●	●	●	●	●	●	●	●	●	●
185	Piece set   Service à menu	52.469,-	20.447,-												●	●	●	●	●	●	●	●	●	●	●
004	Menu spoon   Cuiller à menu	298,-	95,-												●	●	●	●	●	●	●	●	●	●	●
005	Menu fork   Fourchette à menu	298,-	95,-	●	●	●	●	●	●	●	●	●	●	●											
006	Menu knife   Couteau à menu	257,-	122,-	●	●	●	●	●	●	●	●	●	●	●											
106	Menu knife   Couteau à menu – Frozen Black	297,-	162,-	●	●	●	●	●	●	●	●	●	●	●											
001	Table spoon   Cuiller de table	304,-	97,-	●	●	●	●	●	●	●	●	●	●	●											
002	Table fork   Fourchette de table	304,-	97,-	●	●	●	●	●	●	●	●	●	●	●											
003	Table knife   Couteau de table	276,-	128,-	●	●	●	●	●	●	●	●	●	●	●											
007	Dessert spoon   Cuiller à dessert	270,-	94,-	●	●	●	●	●	●	●	●	●	●	●											
008	Dessert fork   Fourchette à dessert	270,-	94,-	●	●	●	●	●	●	●	●	●	●	●											
009	Dessert knife   Couteau à dessert	239,-	120,-	●	●	●	●	●	●	●	●	●	●	●											
020	Coffee spoon, large   Cuiller à café, grand	172,-	80,-	●	●	●	●	●	●	●	●	●	●	●											
021	Coffee spoon   Cuiller à café	151,-	76,-	●	●	●	●	●	●	●	●	●	●	●											
022	Tea spoon III   Cuiller à thé	124,-	61,-	●	●	●	●	●	●	●	●	●	●	●											
023	Mocha-/espresso spoon   Cuiller à moka	116,-	58,-	●	●	●	●	●	●	●	●	●	●	●											
027	Cake fork, large   Fourchette à gâteaux, grande	181,-	78,-	●	●	●	●	●	●	●	●	●	●	●											
068	Cake knife   Couteau à gâteaux	204,-	120,-	●	●	●	●	●	●	●	●	●	●	●											
028	Oyster fork   Fourchette à huîtres	257,-	121,-	●	●	●	●	●	●	●	●	●	●	●											
083	Butter spreader   Tartineur	204,-	120,-	●	●	●	●	●	●	●	●	●	●	●											
026	Ice-cream spoon   Cuiller à glace	172,-	80,-	●	●	●	●	●	●	●	●	●	●	●											
010	Fish knife   Couteau à poisson	323,-	103,-	●	●	●	●	●	●	●	●	●	●	●											
011	Fish fork   Fourchette à poisson	323,-	103,-	●	●	●	●	●	●	●	●	●	●	●											
097	Gourmet spoon   Cuiller gourmet	323,-	103,-	●	●	●	●	●	●	●	●	●	●	●											
029	Lobster fork   Fourchette à homard	311,-	134,-	●	●	●	●	●	●	●	●	●	●	●											
068	Fruit knife   Couteau à fruits	204,-	120,-	●	●	●	●	●	●	●	●	●	●	●											
084	Steak knife   Couteau à steak	271,-	134,-	●	●	●	●	●	●	●	●	●	●	●											
184	Steak knife Frozen Black   Couteau à steak – Frozen Black	299,-	162,-	●	●	●	●	●	●	●	●	●	●	●											
025	Broth spoon   Cuiller à consommé	276,-	95,-	●	●	●	●	●	●	●	●	●	●	●											
091/092	Butter and cheese knife	464,-	258,-	●	●	●	●	●	●	●	●	●	●	●											
045/046	Fish serving knife and fork   Service à poisson	1.470,-	546,-	●	●	●	●	●	●	●	●	●	●	●											
031	Meat fork, large   Fourchette à viande, grande	278,-	113,-	●	●	●	●	●	●	●	●	●	●	●											
032	Meat fork, small   dito, petite	223,-	101,-	●	●	●	●	●	●	●	●	●	●	●											
050	Pastry server   Pelle à gâteaux	384,-	147,-	●	●	●	●	●	●	●	●	●	●	●											
038	Vegetable fork   Fourchette à légumes	700,-	253,-	●	●	●	●	●	●	●	●	●	●	●											
033	Vegetable server   Cuiller à légumes	700,-	244,-	●	●	●	●	●	●	●	●	●	●	●											
034	Potato server   Cuiller à pommes de terre	700,-	244,-	●	●	●	●	●	●	●	●	●	●	●											
014	Children's spoon   Cuiller pour enfants	182,-	75,-	●	●	●	●	●	●	●	●	●	●	●											
015	Children's fork   Fourchette pour enfants	182,-	75,-	●	●	●	●	●	●	●	●	●	●	●											
016	Children's knife   Couteau pour enfants	204,-	120,-	●	●	●	●	●	●	●	●	●	●	●											
040	Compote spoon, large   Cuiller à entremets, grand	700,-	244,-	●	●	●	●	●	●	●	●	●	●	●											
042	Compote spoon, small   dito, petite	386,-	165,-	●	●	●	●	●	●	●	●	●	●	●											
044	Serving spoon, large   Cuiller à servir, grand	816,-	259,-	●	●	●	●	●	●	●	●	●	●	●											
086	Pierced spoon   Cuillère percée	816,-	259,-	●	●	●	●	●	●	●	●	●	●	●											
025	Cream spoon   Cuiller à crème	276,-	95,-	●	●	●	●	●	●	●	●	●	●	●											
061	Cream spoon, bent   Cuiller à crème, cintrée	242,-	97,-	●	●	●	●	●	●	●	●	●	●	●											
040/041	Salad serving set, large   Service à salade, grand	1.400,-	488,-	●	●	●	●	●	●	●	●	●	●	●											
042/043	Salad serving set, small   dito, petit	772,-	330,-	●	●	●	●	●	●	●	●	●	●	●											
035	Sauce ladle   Cuiller à sauce	563,-	247,-	●	●	●	●	●	●	●	●	●	●	●											
019	Table napkin ring   Rond de serviette	284,-	123,-	●	●	●	●	●	●	●	●	●	●	●											
047	Asparagus server/tongs   Pelle/pince à asperges	1.025,-	427,-	●	●	●	●	●	●	●	●	●	●	●											
036	Soup ladle   Louche	1.189,-	431,-	●	●	●	●	●	●	●	●	●	●	●											
052	Tart server   Pelle à tarte	538,-	199,-	●	●	●	●	●	●	●	●	●	●	●											
054	Tart knife   Couteau à tarte	323,-	200,-	●	●	●	●	●	●	●	●	●	●	●											
048/049	Carving set   Service à découper	748,-	452,-	●	●	●	●	●	●	●	●	●	●	●											
148/149	Carving set Frozen Black   Service à découper Frozen Black	878,-	582,-	●	●	●	●	●	●	●	●	●	●	●											
064	Sugar spoon   Cuiller à sucre	172,-	80,-	●	●	●	●	●	●	●	●	●	●	●											
065	Sugar tongs   Pince à sucre	243,-	116,-	●	●	●	●	●	●	●	●	●	●	●											

062	071	046	061	070	063	048	010	064	038	020	069	055	Availability guaranteed until 2040 Garantie de Réassortiment jusqu'en 2040		
Dante	Eclipse	Französisch-Perl*	Glo*	Hermitage*	Martelé	Navette	Ostfriesen*	Riva	Rosenmuster*	Spaten	Sphinx	Viva	Art. No.   Art. Nr.		
●	●	●	●	●	●	●	●	●	●	●	●	●	●	Menu spoon   Cuiller à menu	004
●	●	●	●	●	●	●	●	●	●	●	●	●	●	Menu fork   Fourchette à menu	005
●	●	●	●	●	●	●	●	●	●	●	●	●	●	Menu knife   Couteau à menu	006
					●			●						Menu knife   Couteau à menu – Frozen Black	106
						●	●			●				Table spoon   Cuiller de table	001
						●	●			●				Table fork   Fourchette de table	002
						●	●			●				Table knife   Couteau de table	003
●	●	●	●	●	●	●	●	●	●	●	●	●	●	Dessert spoon   Cuiller à dessert	007
●	●	●	●	●	●	●	●	●	●	●	●	●	●	Dessert fork   Fourchette à dessert	008
●	●	●	●	●	●	●	●	●	●	●	●	●	●	Dessert knife   Couteau à dessert	009
●	●	●	●	●	●	●	●	●	●	●	●	●	●	Coffee spoon, large   Cuiller à café, grande	020
●	●	●	●	●	●	●	●	●	●	●	●	●	●	Coffee spoon   Cuiller à café	021
							●							Tea spoon III   Cuiller à thé	022
●	●	●	●	●	●	●	●	●	●	●	●	●	●	Mocha-/espresso spoon	023
●	●	●	●	●	●	●	●	●	●	●	●	●	●	Cake fork, large   Fourchette à gâteaux, grande	027
●	●	●	●	●	●	●	●	●	●	●	●	●	●	Cake knife   Couteau à gâteaux	068
●		●	●	●	●	●	●		●	●				Oyster fork   Fourchette à huîtres	028
●	●	●	●	●	●	●	●	●	●	●	●	●	●	Butter spreader   Tartineur	083
●	●	●	●	●	●	●	●	●	●	●	●	●	●	Ice-cream spoon   Cuiller à glace	026
●	●	●	●	●	●	●	●	●	●	●	●	●	●	Fish knife   Couteau à poisson	010
●	●	●	●	●	●	●	●	●	●	●	●	●	●	Fish fork   Fourchette à poisson	011
●	●	●	●	●	●	●	●	●	●	●	●	●	●	Gourmet spoon   Cuiller gourmet	097
		●	●	●	●	●	●	●	●	●	●	●	●	Lobster fork   Fourchette à homard	029
●	●	●	●	●	●	●	●	●	●	●	●	●	●	Fruit knife   Couteau à fruits	068
●	●	●	●	●	●	●	●	●	●	●	●	●	●	Steak knife   Couteau à steak	084
					●			●						Steak knife Frozen Black   Couteau à steak – Frozen Black	184
●	●	●	●	●	●	●	●	●	●	●	●	●	●	Broth spoon   Cuiller à consommé	025
●	●	●	●	●	●	●	●	●	●	●	●	●	●	Butter and cheese knife	091/092
●	●	●	●	●	●	●	●	●	●	●	●	●	●	Fish serving knife and fork   Service à poisson	045/046
		●	●	●	●	●	●	●	●	●	●	●	●	Meat fork, large   Fourchette à viande, grande	031
		●	●	●	●	●	●	●	●	●	●	●	●	Meat fork, small   dito, petite	032
		●	●	●	●	●	●	●	●	●	●	●	●	Pastry server   Pelle à gâteaux	050
●	●	●	●	●	●	●	●	●	●	●	●	●	●	Vegetable fork   Fourchette à légumes	038
●	●	●	●	●	●	●	●	●	●	●	●	●	●	Vegetable server   Cuiller à légumes	033
●	●	●	●	●	●	●	●	●	●	●	●	●	●	Potato server   Cuiller à pommes de terre	034
		●					●	●	●	●				Children's spoon   Cuiller pour enfants	014
		●					●	●	●	●				Children's fork   Fourchette pour enfants	015
		●					●	●	●	●				Children's knife   Couteau pour enfants	016
●	●	●	●	●	●	●	●	●	●	●	●	●	●	Compote spoon, large   Cuiller à entremets, grande	040
●	●	●	●	●	●	●	●	●	●	●	●	●	●	Compote spoon, small   dito, petite	042
●	●	●	●	●	●	●	●	●	●	●	●	●	●	Serving spoon, large   Cuiller à servir, grande	044
	●			●										Pierced Spoon   Cuillère percée	086
●	●	●	●	●	●	●	●	●	●	●	●	●	●	Cream spoon   Cuiller à crème	025
				●										Cream spoon, bent   Cuiller à crème, cintrée	061
●	●	●	●	●	●	●	●	●	●	●	●	●	●	Salad serving set, large   Service à salade, grande	040/041
●	●	●	●	●	●	●	●	●	●	●	●	●	●	Salad serving set, small   dito, petite	042/043
●	●	●	●	●	●	●	●	●	●	●	●	●	●	Sauce ladle   Cuiller à sauce	035
●	●	●	●	●	●	●	●	●	●	●	●	●	●	Table napkin ring   Rond de serviette	019
●	●	●	●	●	●	●	●	●	●	●	●	●	●	Asparagus server/tongs   Pelle/pince à asperges	047
●	●	●	●	●	●	●	●	●	●	●	●	●	●	Soup ladle   Louche	036
●	●	●	●	●	●	●	●	●	●	●	●	●	●	Tart server   Pelle à tarte	052
●	●	●	●	●	●	●	●	●	●	●	●	●	●	Tart knife   Couteau à tarte	054
●	●	●	●	●	●	●	●	●	●	●	●	●	●	Carving knife and fork   Service à découper	048/049
					●			●						Carving set Frozen Black   Service à découper Frozen Black	148/149
●	●	●	●	●	●	●	●	●	●	●	●	●	●	Sugar spoon   Cuiller à sucre	064
●	●	●	●	●	●	●	●	●	●	●	●	●	●	Sugar tongs   Pince à sucre	065

\*This pattern is alternatively available with gilded decor (p. 12) | \*Modèles alternativement avec décor doré (p. 12)

ES CUBERTERÍAS DE PLATA Y CON BAÑO DE PLATA		072	050	053	045	040	019	056	060	044	068	057
NL ZILVEREN EN VERZILVERDE BESTEKKEN												
IT POSATE D'ARGENTO E ARGENTATE												
Composition of sets (p. 14)		925 Sterling Silver	150 massive silver plated									
4	Cubertería de mesa   Tafelbestek   Posto tavola	1.004,-	388,-									
9	Piezas de servir   Diengarnituur   Posate da servire	4.321,-	1.603,-									
24	Cubertería de mesa   Tafelbestek   Posto tavola	6.024,-	2.328,-									
30	Cubertería de mesa   Tafelbestek   Posto tavola	7.110,-	2.796,-									
39	Cubertería de mesa   Tafelbestek   Posto tavola	11.431,-	4.399,-									
69	Cubertería de mesa   Tafelbestek   Posto tavola	18.541,-	7.195,-									
69 NL	Cubertería de mesa   Tafelbestek   Posto tavola	18.892,-	7.474,-									
75	Cubertería de mesa   Tafelbestek   Posto tavola	20.745,-	8.125,-									
110	Cubertería de mesa   Tafelbestek   Posto tavola	30.548,-	11.321,-									
128	Cubertería de mesa   Tafelbestek   Posto tavola	36.653,-	13.738,-									
133	Cubertería de mesa   Tafelbestek   Posto tavola	37.878,-	14.281,-									
185	Cubertería de mesa   Tafelbestek   Posto tavola	52.469,-	20.447,-									
Ref.   Art.-Nr.   Art. no.												
004	Cuchara mesa   Tafellepel   Cucchiaio tavola	298,-	95,-	●	●	●	●	●	●	●	●	●
005	Tenedor mesa   Tafelvork   Forchetta tavola	298,-	95,-	●	●	●	●	●	●	●	●	●
006	Cuchillo mesa   Tafelmes   Coltello tavola	257,-	122,-	●	●	●	●	●	●	●	●	●
106	Cuchillo mesa   Tafelmes   Coltello tavola – Frozen Black	297,-	162,-								●	
001	Cuchara banquete   Tafellepel, groot   Cucchiaio tavola, grande	304,-	97,-		●				●	●		
002	Tenedor banquete   Tafelvork, groot   Forchetta tavola, grande	304,-	97,-		●				●	●		
003	Cuchillo banquete   Tafelmes, groot   Coltello tavola, grande	276,-	128,-		●				●	●		
007	Cuchara postre/entremés   Dessertlepel   Cucchiaio frutta	270,-	94,-	●	●	●	●	●	●	●	●	●
008	Tenedor postre/entremés   Dessertvork   Forchetta frutta	270,-	94,-	●	●	●	●	●	●	●	●	●
009	Cuchillo postre/entremés   Dessertvork   Coltello frutta	239,-	120,-	●	●	●	●	●	●	●	●	●
020	Cuchara café, grande   Koffielepel, groot   Cucchiaio tè e colazione	172,-	80,-	●	●	●	●	●	●	●	●	●
021	Cuchara café   Koffielepel   Cucchiaio caffè-tè	151,-	76,-	●	●	●	●	●	●	●	●	●
022	Cuchara té   Theelepels III   Cucchiaio tè	124,-	61,-									
023	Cuchara moca   Mokka-/Espressoepel   Cucchiaio moca/espresso	116,-	58,-	●	●	●	●	●	●	●	●	●
027	Tenedor tarta   Taartvorkje   Forchetta dolci	181,-	78,-	●	●	●	●	●	●	●	●	●
068	Cuchillo tarta   Fruitmesje = Taartmesje   Coltello dolci	204,-	120,-	●	●	●	●	●	●	●	●	●
028	Tenedor ostras   Oestervork   Forchetta ostriche	257,-	121,-		●	●	●	●	●	●	●	●
083	Cuchillo de mantequilla   Boterspreider   Coltello burro	204,-	120,-		●	●	●	●	●	●	●	●
026	Cuchara helado   Ijslepel = Puddinglepel   Cucchiaio gelato	172,-	80,-	●	●	●	●	●	●	●	●	●
010	Cuchillo pescado   Vismes   Coltello pesce	323,-	103,-	●	●	●	●	●	●	●	●	●
011	Tenedor pescado   Visvork   Forchetta pesce	323,-	103,-	●	●	●	●	●	●	●	●	●
097	Cuchara gourmet   Gourmetlepel   Cucchiaio salsa individuale	323,-	103,-	●	●	●	●	●	●	●	●	●
029	Tenedor de marisco   Kreeftefvork   Forchetta aragosta	311,-	134,-	●	●	●	●	●	●	●	●	●
068	Cuchillo fruta   Fruitmes (Taartmesje)   Coltello dolci	204,-	120,-	●	●	●	●	●	●	●	●	●
084	Cuchillo steak   Steakmes   Coltello bistecca	271,-	134,-	●	●	●	●	●	●	●	●	●
184	Cuchillo steak   Steakmes   Coltello bistecca – Frozen Black	299,-	162,-								●	
025	Cuchara taza   Bouillonlepel/Roomlepel   Cucchiaio brodo/panna	276,-	95,-	●	●	●	●	●	●	●	●	●
091/092	Cubierto de mantequilla y queso   B.- en Kaasmesje   Coltello burro/formaggio	464,-	258,-	●	●	●	●	●	●	●	●	●
045/046	Cubierto servir pescado   Visdiencouvert   Coltello e forch. servire pesce	1.470,-	546,-	●	●	●	●	●	●	●	●	●
031	Tenedor carne, grande   Vleesdienvork, groot   Forchetta carne, grande	278,-	113,-	●	●	●	●	●	●	●	●	●
032	ídem, pequeño   Vleesdienvork, klein   Forchetta carne, piccola	223,-	101,-	●	●	●	●	●	●	●	●	●
050	Pala bizcocho   Gebakscjep   Pala dolci	384,-	147,-		●	●	●	●	●	●	●	●
038	Tenedor verdura   Dienvork   Forchetta legumi	700,-	253,-	●	●	●	●	●	●	●	●	●
033	Cuchara verdura   Groentelepel   Cucchiaio legumi	700,-	244,-	●	●	●	●	●	●	●	●	●
034	Cuchara patatas   Aardappelpepel   Cucchiaio patate	700,-	244,-	●	●	●	●	●	●	●	●	●
014	Cuchara infantil   Kinderlepel   Cucchiaio per bambini	182,-	75,-		●	●	●	●		●	●	●
015	Tenedor infantil   Kindervork   Forchetta per bambini	182,-	75,-		●	●	●	●		●	●	●
016	Cuchillo infantil   Kindermes   Coltello per bambini	204,-	120,-		●	●	●	●		●	●	●
040	Cuchara compota, grande   Puddingschep, groot   Cucchiaio serv. insalata, gr.	700,-	244,-	●	●	●	●	●	●	●	●	●
042	ídem, pequeña   Puddingschep, klein   Cucchiaio serv. insalata, picc.	386,-	165,-		●	●	●	●	●	●	●	●
044	Cuchara servir   Dienlepel, groot   Cucchiaio servire, gr.	816,-	259,-	●	●	●	●	●	●	●	●	●
086	Espumadera   Opengewerkt lepel   Schiumarola	816,-	259,-									
025	Cuchara nata   Slagroomlepel   Cucchiaio brodo/panna	276,-	95,-	●	●	●	●	●	●	●	●	●
061	Cuchara nata, curvada   Slagroomlepel, gebogen   Cucchiaio panna, piegato	242,-	97,-	●	●	●	●	●	●	●	●	●
040/041	Cubierto ensalada, grande   Saladecouvert, groot   Cucch. e forch. serv. ins., gr.	1.400,-	488,-	●	●	●	●	●	●	●	●	●
042/043	ídem, pequeño   Saladecouvert, klein   Cucch. e forch. serv. ins., picc.	772,-	330,-		●	●	●	●	●	●	●	●
035	Cuchara salsa   Sauslepel   Cucchiaio salsa	563,-	247,-	●	●	●	●	●	●	●	●	●
019	Servilletero   Servetring   Portotavagliolo	284,-	123,-	●	●	●	●	●	●	●	●	●
047	Pala/pinzas para espárragos   Aspergeschep/-tang   Paletta/Pinza per asparagi	1.025,-	427,-		●	●	●	●	●	●	●	●
036	Cazo sopa   Soeplepel   Mestolo	1.189,-	431,-	●	●	●	●	●	●	●	●	●
052	Pala tarta   Taartschep   Pala torta	538,-	199,-	●	●	●	●	●	●	●	●	●
054	Cuchillo tarta   Taartmes   Coltello torta	323,-	200,-	●	●	●	●	●	●	●	●	●
048/049	Cubierto trinchar   Trancheercouvert   Coltello e forchetta trinciante	748,-	452,-	●	●	●	●	●	●	●	●	●
148/149	Cubierto trinchar   Trancheercouvert   Coltello e forchetta trinciante – Frozen Black	878,-	582,-								●	
064	Cucharilla azúcar   Suikerlepel   Cucchiaio zucchero	172,-	80,-	●	●	●	●	●	●	●	●	●
065	Pinzas azúcar   Suikertang   Pinza zucchero	243,-	116,-	●	●	●	●	●	●	●	●	●

062	071	046	061	070	063	048	010	064	038	020	069	055		
Dante	Eclipse	Französisch-Perl*	Glo*	Hermitage*	Martelé	Navette	Ostfriesen*	Riva	Rosenmuster*	Spaten	Sphinx	Viva	<p>Garantía postventa hasta 2040</p> <p>Nakoopgarantie tot 2040</p> <p>Garanzia di riassortimento sino al 2040</p>	
													Ref.   Art.-Nr.   Art. no.	
●	●	●	●	●	●	●	●	●	●	●	●	●	Cuchara mesa   Tafellepel   Cucchiaio tavola	004
●	●	●	●	●	●	●	●	●	●	●	●	●	Tenedor mesa   Tafelvork   Forchetta tavola	005
●	●	●	●	●	●	●	●	●	●	●	●	●	Cuchillo mesa   Tafelmes   Coltello tavola	006
					●			●					Cuchillo mesa   Tafelmes   Coltello tavola – Frozen Black	106
						●	●			●			Cuchara banquete   Tafellepel, groot   Cucchiaio tavola, grande	001
						●	●			●			Tenedor banquete   Tafelvork, groot   Forchetta tavola, grande	002
						●	●			●			Cuchillo banquete   Tafelmes, groot   Coltello tavola, grande	003
●	●	●	●	●	●	●	●	●	●	●	●	●	Cuchara postre/entremés   Dessertlepel   Cucchiaio frutta	007
●	●	●	●	●	●	●	●	●	●	●	●	●	Tenedor postre/entremés   Dessertvork   Forchetta frutta	008
●	●	●	●	●	●	●	●	●	●	●	●	●	Cuchillo postre/entremés   Dessertmes   Coltello frutta	009
●	●	●	●	●	●	●	●	●	●	●	●	●	Cuchara café, grande   Koffielepel, groot   Cucchiaio tè e colazione	020
●	●	●	●	●	●	●	●	●	●	●	●	●	Cuchara café   Koffielepel   Cucchiaio caffè-tè	021
							●						Cuchara té   Theelep   Cucchiaio tè	022
●	●	●	●	●	●	●	●	●	●	●	●	●	Cuchara moca   Mokka-/Espressoel   Cucchiaio moca/espresso	023
●	●	●	●	●	●	●	●	●	●	●	●	●	Tenedor tarta   Taartvorkje   Forchetta dolci	027
●	●	●	●	●	●	●	●	●	●	●	●	●	Cuchillo tarta   Fruitmesje = Taartmesje   Coltello dolci	068
●	●	●	●	●	●	●	●	●	●	●	●	●	Tenedor ostras   Oestervork   Forchetta ostriche	028
●	●	●	●	●	●	●	●	●	●	●	●	●	Cuchillo de mantequilla   Boterspreider   Coltello burro	083
●	●	●	●	●	●	●	●	●	●	●	●	●	Cuchara helado   Ijslepel = Puddinglepel   Cucchiaio gelato	026
●	●	●	●	●	●	●	●	●	●	●	●	●	Cuchillo pescado   Vismes   Coltello pesce	010
●	●	●	●	●	●	●	●	●	●	●	●	●	Tenedor pescado   Visvork   Forchetta pesce	011
●	●	●	●	●	●	●	●	●	●	●	●	●	Cuchara gourmet   Gourmetlepel   Cucchiaio salsa individual	097
●	●	●	●	●	●	●	●	●	●	●	●	●	Tenedor de marisco   Kreeftenvork   Forchetta aragosta	029
●	●	●	●	●	●	●	●	●	●	●	●	●	Cuchillo fruta   Fruitmes (Taartmesje)   Coltello dolci	068
●	●	●	●	●	●	●	●	●	●	●	●	●	Cuchillo steak   Steakmes   Coltello bistecca	084
								●					Cuchillo steak   Steakmes   Coltello bistecca – Frozen Black	184
●	●	●	●	●	●	●	●	●	●	●	●	●	Cuchara taza   Bouillonlepel/Roomlepel   Cucchiaio brodo/panna	025
●	●	●	●	●	●	●	●	●	●	●	●	●	Cubierto de mantequilla y queso   B.- en Kaasmesje   Coltello burro/formaggio	091/092
●	●	●	●	●	●	●	●	●	●	●	●	●	Cubierto servir pescado   Visdiencouvert   Coltello e forch. servire pesce	045/046
●	●	●	●	●	●	●	●	●	●	●	●	●	Tenedor carne, grande   Vleesdienvork, groot   Forchetta carne, grande	031
		●	●	●	●	●	●	●	●	●	●	●	ídem, pequeño   Vleesdienvork, klein   Forchetta carne, piccola	032
		●	●	●	●	●	●	●	●	●	●	●	Pala bizcocho   Gebaksclep   Pala dolci	050
●	●	●	●	●	●	●	●	●	●	●	●	●	Tenedor verdura   Dienvork   Forchetta legumi	038
●	●	●	●	●	●	●	●	●	●	●	●	●	Cuchara verdura   Groentelepel   Cucchiaio legumi	033
●	●	●	●	●	●	●	●	●	●	●	●	●	Cuchara patatas   Aardappel   Cucchiaio patate	034
		●							●	●			Cuchara infantil   Kinderlepel   Cucchiaio per bambini	014
		●							●	●			Tenedor infantil   Kindervork   Forchetta per bambini	015
		●							●	●			Cuchillo infantil   Kindermes   Coltello per bambini	016
●	●	●	●	●	●	●	●	●	●	●	●	●	Cuchara compota, grande   Puddingschep, groot   Cucchiaio serv. insalata, gr.	040
●	●	●	●	●	●	●	●	●	●	●	●	●	ídem, pequeña   Puddingschep, klein   Cucchiaio serv. insalata, picc.	042
●	●	●	●	●	●	●	●	●	●	●	●	●	Cuchara servir   Dienlepel, groot   Cucchiaio servire, gr.	044
	●			●									Espumadera   Opengewerkt lepel   Schiumarola	086
●	●	●	●	●	●	●	●	●	●	●	●	●	Cuchara nata   Slagroomlepel   Cucchiaio brodo/panna	025
●	●	●	●	●	●	●	●	●	●	●	●	●	Cuchara nata, curvada   Slagroomlepel, gebogen   Cucchiaio panna, piegato	061
●	●	●	●	●	●	●	●	●	●	●	●	●	Cubierto ensalada, grande   Saladecouvert, groot   Cucch. e forch. serv. ins., gr.	040/041
●	●	●	●	●	●	●	●	●	●	●	●	●	ídem, pequeño   Saladecouvert, klein   Cucch. e forch. serv. ins., picc.	042/043
●	●	●	●	●	●	●	●	●	●	●	●	●	Cuchara salsa   Sauslepel   Cucchiaio salsa	035
●	●	●	●	●	●	●	●	●	●	●	●	●	Servilletero   Servetring   Portatovagliolo	019
●	●	●	●	●	●	●	●	●	●	●	●	●	Pala/pinzas para espárganos   Aspergeschep/-tang   Paleta/Pinza per asparagi	047
●	●	●	●	●	●	●	●	●	●	●	●	●	Cazo sopa   Soeplepel   Mestolo	036
●	●	●	●	●	●	●	●	●	●	●	●	●	Pala tarta   Taartsclep   Pala torta	052
●	●	●	●	●	●	●	●	●	●	●	●	●	Cuchillo tarta   Taartmes   Coltello torta	054
●	●	●	●	●	●	●	●	●	●	●	●	●	Cubierto trinchar   Trancheercouvert   Coltello e forchetta trinciante	048/049
●	●	●	●	●	●	●	●	●	●	●	●	●	Cubierto trinchar   Trancheercouvert   Coltello e forchetta trinciante – Frozen Black	148/149
●	●	●	●	●	●	●	●	●	●	●	●	●	Cucharilla azúcar   Suikerlepel   Cucchiaio zucchero	064
●	●	●	●	●	●	●	●	●	●	●	●	●	Pinzas azúcar   Suikertang   Pinza zucchero	065

\*Modelos con adorno bañado en oro (pág. 12) | \*Modellen alternatief decorverguld (p. 12) | \*Questo modello è disponibile, a richiesta, con decorazione in oro (p. 12)

## Shape and size of individual pieces

La forme et la taille des pièces individuelles

Forma y tamaño de cada pieza

## Vorm en afmetingen von individuele delen

Forma e misura dei singoli pezzi



- |  |   |  |  |  |
|--|---|--|--|--|
| 001 table spoon, 21,0 cm<br>Cuiller de table   Cuchara banquete<br>Tafellepel, groot   Cucchiaino tavola, grande | 003 table knife, 24,5 cm<br>Couteau de table   Cuchillo banquete<br>Tafelmes, groot   Coltello tavola, grande | 008 Dessert fork, 18,2 cm<br>Fourchette à dessert<br>Tenedor postre/entremés<br>Dessert-/Voorgerechtvork<br>Forchetta frutta | 020 coffee spoon large, 14,8 cm<br>Cuiller à café, grande<br>Cuchara café, grande<br>Koffielepel, groot<br>Cucchiaino tè e colazione | 023 Mocha spoon, 10,3 cm<br>Cuiller à moka<br>Cuchara moka<br>Thee-/Espressoepel<br>Cucchiaino moca/espresso |
| 004 Menu spoon, 20,2 cm<br>Cuiller à menu   Cuchara mesa<br>Tafellepel   Cucchiaino tavola                       | 006 menu knife, 23,5 cm<br>Couteau à menu   Cuchillo mesa<br>Tafelmes   Coltello tavola                       | 007 Dessert spoon, 18,5 cm<br>Cuiller à dessert<br>Cuchara postre/entremés<br>Dessert-/Voorgerechtlepel<br>Cucchiaino frutta | 009 Dessert knife, 21,4 cm<br>Couteau à dessert<br>Cuchillo postre/entremés<br>Dessert-/Voorgerechtmes<br>Coltello frutta            | 021 Coffee spoon, 13,3 cm<br>Cuiller à café<br>Cuchara café<br>Koffielepel<br>Cucchiaino caffè-tè            |



- |  |   |   |   |   |
|--|---|---|---|---|
| 029 Lobster fork, 18,5 cm<br>Fourchette à homard<br>Tenedor de marisco<br>Kreeftenvork<br>Forchetta aragosta | 025 Broth spoon, 15,1 cm<br>Cuiller à consommé<br>Cuchara taza<br>Bouillonlepel<br>Cucchiaino brodo   | 091 Butter knife, hollow handle, 20,0 cm<br>Couteau à beurre, lame inox<br>Cuchillo mantequilla con hoja de acero<br>Botermesje met stalen lemmet<br>Coltello burro | 092 Cheese knife, hollow handle, 20,5 cm<br>Couteau à fromage, lame inox<br>Cuchillo queso con hoja de acero<br>Kaasmesje met stalen lemmet<br>Coltello formaggio | 045 Fish serving knife, 29,3 cm<br>Couteau à servir le poisson<br>Cuchillo servir pescado<br>Visdienmes<br>Coltello pesce |
| 084 Steak knife, 23,0 cm<br>Couteau à steak<br>Cuchillo steak<br>Steakmes<br>Coltello bistecca               | 091 Butter knife, hollow handle, 20,0 cm<br>Couteau à beurre, lame inox<br>Cuchillo mantequilla con hoja de acero<br>Botermesje met stalen lemmet<br>Coltello burro | 046 Fish serving fork, 21,6 cm<br>Fourchette à servir le poisson<br>Tenedor servir pescado<br>Visdienvork<br>Forchetta servire pesce                                |   |   |



- |   |   |  |   |   |
|---|---|--|---|---|
| 042 Compote spoon, small, 19,0 cm<br>Cuiller à entremets, petite<br>Cuchara compota, pequeña<br>Puddingschep, klein<br>Cucchiaino servire insalata, piccolo | 025 Cream spoon, 15,1 cm<br>Cuiller à crème<br>Cuchara nata<br>Slagroomlepel<br>Cucchiaino panna  | 041 Salad fork, large, 20,5 cm<br>Fourchette à servir la salade, grande<br>Tenedor ensalada, grande<br>Saladevork, groot<br>Forchetta servire insalata, grande | 043 Salad fork, small, 19,0 cm<br>Fourchette à servir la salade, petite<br>Tenedor ensalada pequeño<br>Saladevork, klein<br>Forchetta servire insalata, piccola | 035 Sauce ladle, 17,5 cm<br>Cuiller à sauce<br>Cuchara salsa<br>Sauslepel<br>Cucchiaino salsa |
| 044 Serving spoon, large, 27,0 cm<br>Cuiller à servir, grande<br>Cuchara servir<br>Dienlepel, groot<br>Cucchiaino servire, gr.                              | 040 Salad spoon, large, 20,5 cm<br>Cuiller à servir la salade, grande<br>Cuchara ensalada, grande<br>Saladelepel, groot<br>Cucchiaino serv. insalata, gr. | 042 Salad spoon, small, 19,0 cm<br>Cuiller à servir la salade, petite<br>Cuchara ensalada pequeña<br>Saladelepel, klein<br>Cucchiaino servire insalata         |   |   |



The shape of each piece is individually styled to match the respective cutlery pattern. The individual pieces of the pattern Alt-Spaten illustrated below as well as the measures indicated do therefore only serve as a clue for other patterns.

La forme et la taille des pièces individuelles varient d'un modèle à l'autre. Les pièces individuelles du modèle Alt-Spaten illustrées ici et les mesures approximatives indiquées ici ne peuvent donc servir que d'indication pour d'autres modèles.

La forma y la longitud de cada pieza varía en función del modelo. Las piezas aquí reproducidas del modelo Alt-Spaten y las medidas aproximadas que se indican sólo pretenden ser orientativos.

Vorm en afmetingen van individuele delen variëren van model tot model. De hier afgebeelde delen van het model Alt-Spaten en de aangegeven circa maten dienen uitsluitend als leidraad.

Forma e lunghezza dei singoli pezzi variano da modello a modello. Le posate esposte qui sono del modello Alt-Spaten e le misure all'incirca sono un tipo di indicazione.



027 Cake fork, 15,3 cm  
Fourchette à gâteaux  
Tenedor tarta  
Taartvorkje  
Forchetta dolci



068 Cake knife/fruit knife, 16,4 cm  
Couteau à gâteaux  
Cuchillo tarta  
Fruitmesje  
Coltello dolci



028 Oyster fork, 14,7 cm  
Fourchette à huîtres  
Tenedor ostras  
Oestervork  
Forchetta ostriche



026 Ice-cream spoon, 14,8 cm  
Cuiller à glace  
Cuchara helado  
Ijslepel  
Cucchiario gelato



011 Fish fork, 17,6 cm  
Fourchette à poisson  
Tenedor pescado  
Visvork  
Forchetta pesce



010 Fish knife, 21,0 cm  
Couteau à poisson  
Cuchillo pescado  
Vismes  
Coltello pesce



097 Gourmet spoon, 18,5 cm  
Cuiller gourmet  
Cuchara gourmet  
Vis-, Sauslepel  
Cucchiario salsa individuale



031 Meat fork, large, 18,2 cm  
Fourchette à viande, grande  
Tenedor carne, grande  
Vleesdienvork, groot  
Forchetta carne, grande



032 Meat fork, small, 15,1 cm  
Fourchette à viande, petite  
Tenedor carne, pequeño  
Vleesdienvork, klein  
Forchetta carne, piccola



038 Vegetable fork, 23,0 cm  
Fourchette à légumes  
Pala verdura  
Groentevork  
Forchetta legumi



050 Pastry server, 16,7 cm  
Pelle à gâteaux  
Pala bizcocho  
Gebakscjep  
Pala dolci



033 Vegetable server, 23,1 cm  
Cuiller à légumes  
Cuchara verdura  
Groentelepел  
Cucchiario legumi



040 Compote spoon, large, 20,5 cm  
Cuiller à entremets, grande  
Cuchara compota, grande  
Puddingscjep, groot  
Cucchiario servire insalata, grande



034 Potato server, 23,0 cm  
Cuiller à pommes de terre  
Cuchara patatas  
Aardappelpepel  
Cucchiario patate



019 Table napkin ring, 5,4 cm  
Lien de serviette  
Servilletero  
Servetring  
Portatovagliolo



047 Asparagus server/tongs, 21,5 cm  
Pelle/pince à asperges  
Pala/pinza espárragos  
Aspergescjep/-tang  
Pala/pinze asparagi



036 Soup ladle, 27,5 cm  
Louche  
Cazo sopa  
Soeplepel  
Mestolo



054 Tart knife, 26,0 cm  
Couteau à tarte  
Cuchillo tarta  
Taartmes  
Coltello torta



049 Carving fork, 22,8 cm  
Fourchette à découper  
Tenedor trinchar  
Trancheevork  
Forchetta trinciante



048 Carving knife, 25,4 cm  
Couteau à découper  
Cuchillo trinchar  
Trancheermes  
Coltello trinciante







065 Sugar tongs, 9,4 cm  
Pince à sucre  
Pinzas azúcar  
Suikertang  
Pinza zucchero



064 Sugar spoon, 12,9 cm  
Cuiller à sucre  
Cucharilla azúcar  
Suikerlepel  
Cucchiario zucchero



Length of items (cm) Longueur des articles individuels (cm) Longitud de los artículos (cm) Lengte van de items (cm) Lunghezza degli articoli (cm)		072	050	053	045
Art. No.   Art. Nr.   Ref.   Art.-Nr.   Art. no.					
004	Menu spoon   Cuiller à menu   Cuchara mesa   Tafellepel   Cucchiaio tavola	21,4	20,3	20,4	20,4
005	Menu fork   Fourchette à menu   Tenedor mesa   Tafelvork   Forchetta tavola	21,0	19,8	20,0	19,6
006	Menu knife   Couteau à menu   Cuchillo mesa   Tafelmes   Coltello tavola	23,7	21,6	23,1	22,9
106	Menu knife   Couteau à menu   Cuchillo mesa   Tafelmes   Coltello tavola – Frozen Black				
001	Table spoon   Cuiller de table   Cuchara banquete   Tafellepel, groot   Cucchiaio tavola, grande		21,3		
002	Table fork   Fourchette de table   Tenedor banquete   Tafelvork, groot   Forchetta tavola, grande		20,6		
003	Table knife   Couteau de table   Cuchillo banquete   Tafelmes, groot   Coltello tavola, grande		23,6		
007	Dessert spoon   Cuiller à dessert   Cuchara postre/entremés   Dessertlepel   Cucchiaio frutta	19,6	18,3	18,4	19,0
008	Dessert fork   Fourchette à dessert   Tenedor postre/entremés   Dessertvork   Forchetta frutta	19,1	18,0	18,0	18,5
009	Dessert knife   Couteau à dessert   Cuchillo postre/entremés   Dessertmes   Coltello frutta	21,8	19,8	21,3	21,3
020	Coffee spoon, large   Cuiller à café, grand   Cuchara café, grande   Koffielepel, groot   Cucchiaio tè e colazione		15,0	14,7	14,8
021	Coffee spoon   Cuiller à café   Cuchara café   Koffielepel   Cucchiaio caffè-tè	13,8	13,4	12,9	13,0
022	Tea spoon III   Cuiller à thé   Cuchara té   Theelepels III   Cucchiaio tè				
023	Mocha-/espresso spoon   Cuiller à moka   Cuchara moca   Mokka-/Espressolepel   Cucchiaio moca/espresso	11,5	11,0	10,7	10,7
027	Cake fork, large   Fourchette à gâteaux, grande   Tenedor tarta   Taartvorkje   Forchetta dolci	16,0	15,0	15,0	14,7
068	Cake knife   Couteau à gâteaux   Cuchillo tarta   Fruitmesje = Taartmesje   Coltello dolci	17,1	16,5	17,5	16,8
028	Oyster fork   Fourchette à huîtres   Tenedor ostras   Oestervork   Forchetta ostriche		14,8	14,0	14,3
083	Butter spreader   Tartineur   Cuchillo de mantequilla   Boterspreider   Coltello burro		18,4	18,4	18,4
026	Ice-cream spoon   Cuiller à glace   Cuchara helado   Ijslepel = Puddinglepel   Cucchiaio gelato	14,8	14,8	14,5	14,4
010	Fish knife   Couteau à poisson   Cuchillo pescado   Vismes   Coltello pesce	23,0	20,5	20,5	21,5
011	Fish fork   Fourchette à poisson   Tenedor pescado   Visvork   Forchetta pesce	19,1	18,2	17,6	18,1
097	Gourmet spoon   Cuiller gourmet   Cuchara gourmet   Gourmetlepel   Cucchiaio salsa individuale	19,6	18,2	18,2	18,2
029	Lobster fork   Fourchette à homard   Tenedor de marisco   Kreeftenvork   Forchetta aragosta		21,2	18,5	18,5
068	Fruit knife   Couteau à fruits   Cuchillo fruta   Fruitmes (Taartmesje)   Coltello dolci		16,5	17,5	16,8
084	Steak knife   Couteau à steak   Cuchillo steak   Steakmes   Coltello bistecca	24,0	22,2	22,5	22,0
184	Steak knife Frozen Black   Couteau à steak Frozen Black   Cuchillo steak   Steakmes   Coltello bistecca (Frozen Black)				
025	Broth spoon   Cuiller à consommé   Cuchara taza   Bouillonlepel/Roomlepel   Cucchiaio brodo/panna	15,6	15,3	15,1	15,2
091	Butter knife   Couteau à beurre   Cuchillo mantequilla   Botermesje   Coltello burro	20,7	19,9	20,1	19,9
092	Cheese knife   Couteau à fromage   Cuchillo queso   Kaasmesje   Coltello formaggio	21,8	19,8	20,4	20,0
045	Fish serving knife   Couteau à servir le poisson   Cuchillo servir pescado   Visdienmes   Coltello pesce	28,2	28,5	28,9	28,7
046	Fish serving fork   Fourchette à servir le poisson   Tenedor servir pescado   Visdienvork   Forchetta servire pesce	26,3	21,4	21,4	21,6
031	Meat fork, large   Fourchette à viande, grande   Tenedor carne, grande   Vleesdienvork, groot   Forchetta carne, grande	19,0	18,1	18,0	17,9
032	Meat fork, small   ditto, petite   idem, pequeño   Vleesdienvork, klein   Forchetta carne, piccola		14,8	15,0	14,8
050	Pastry server   Pelle à gâteaux   Pala bizcocho   Gebakschep   Pala dolci			16,5	16,6
038	Vegetable fork   Fourchette à légumes   Tenedor verdura   Dienvork   Forchetta legumi	23,7	24,5	21,4	22,4
033	Vegetable server   Cuiller à légumes   Cuchara verdura   Groentelepel   Cucchiaio legumi	24,4	25,1	22,4	23,0
034	Potato server   Cuiller à pommes de terre   Cuchara patatas   Aardappelpepel   Cucchiaio patate		24,6	22,0	22,6
014	Children's spoon   Cuiller pour enfants   Cuchara infantil   Kinderlepel   Cucchiaio per bambini		15,5	15,2	18,4
015	Children's fork   Fourchette pour enfants   Tenedor infantil   Kindervork   Forchetta per bambini		15,4	14,6	17,3
016	Children's knife   Couteau pour enfants   Cuchillo infantil   Kindermes   Coltello per bambini		17,8		20,0
040	Compote spoon, large   Cuiller à entremets, grand   Cuchara compota, grande   Puddingschep, groot   Cucchiaio serv. insalata, gr.	29,0	25,5	25,0	20,5
042	Compote spoon, small   ditto, petite   idem, pequeña   Puddingschep, klein   Cucchiaio serv. insalata, picc.		20,0	18,5	18,5
044	Serving spoon, large   Cuiller à servir, grand   Cuchara servir   Dienlepel, groot   Cucchiaio servire, gr.	26,5	28,0	26,0	27,0
086	Pierced spoon   Cuillère percée   Espumadera   Opengewerkt lepel   Schiumarola				
025	Cream spoon   Cuiller à crème   Cuchara nata   Slagroomlepel   Cucchiaio brodo/panna	15,6	15,3	15,1	15,2
061	Cream spoon, bent   Cuiller à crème, cintrée   Cuchara nata, curvada   Slagroomlepel, gebogen   Cucchiaio panna, piegato				
040	Salad spoon, large   Cuiller à servir la salade, grand   Cuchara ensalada, grande   Saladelepel, groot   Cucchiaio serv. insalata, gr.	29,0	25,5	25,0	20,5
041	Salad fork, large   Fourchette à servir la salade, grand   Tenedor ensalada, grande   Saladevork, groot   Forchetta servire insalata, grande	29,2	25,0	24,5	20,0
042	Salad spoon, small   Cuiller à servir la salade, petit   Cuchara ensalada pequeña   Saladelepel, klein   Cucchiaio servire insalata		20,0	18,5	18,5
043	Salad fork, small   Fourchette à servir la salade, petit   Tenedor ensalada pequeño   Saladevork, klein   Forchetta servire insalata, piccola		21,0	18,2	18,4
035	Sauce ladle   Cuiller à sauce   Cuchara salsa   Sauslepel   Cucchiaio salsa	19,1	18,6	17,0	18,5
019	Table napkin ring   Rond de serviette   Servilletero   Servetring   Portatovagliolo		5,8	5,3	5,4
047	Asparagus server/tongs   Pelle/pince à asperges   Pala/pinzas para espárragos   Aspergeschep/-tang   Paletta/Pinza per asparagi		21,6	21,8	21,2
036	Soup ladle   Louche   Cazo sopa   Soeplepel   Mestolo		29,0	28,7	27,6
052	Tart server   Pelle à tarte   Pala tarta   Taartschep   Pala torta	24,6	23,5	23,2	23,4
054	Tart knife   Couteau à tarte   Cuchillo tarta   Taartmes   Coltello torta	28,0	27,5	25,1	25,6
048	Carving knife   Couteau à découper   Cuchillo trinchar   Trancheermes   Coltello trinciante	26,7	30,9	31,2	24,7
148	Carving knife   Couteau à découper   Cuchillo trinchar   Trancheermes   Coltello trinciante (Frozen Black)				
049	Carving fork   Fourchette à découper   Tenedor trinchar   Trancheervork   Forchetta trinciante	27,0	27,0	26,5	22,0
149	Carving fork   Fourchette à découper   Tenedor trinchar   Trancheervork   Forchetta trinciante (Frozen Black)				
064	Sugar spoon   Cuiller à sucre   Cucharilla azúcar   Suikerlepel   Cucchiaio zucchero	14,6	14,0	12,6	13,4
065	Sugar tongs   Pince à sucre   Pinzas azúcar   Suikertang   Pinza zucchero		13,0	9,5	9,4

040	019	056	060	044	068	057	062	071	046	061	070	063	048	010	064	038	020	069	055
Alt-Kopenhagen	Alt-Spaten	Arcade	Art Deco	Avenue	Belvedere	Classic-Faden	Dante	Eclipse	Französisch+Perf	Gio	Hermitage	Martelé	Navette	Ostfriesen	Riva	Rosenmuster	Spaten	Sphinx	Viva
20,1	20,0	20,5	20,2	20,1	20,4	20,5	20,4	20,4	20,2	20,4	21,0	20,4	20,2	19,7	21,9	20,3	20,2	21,2	22,0
19,8	20,4	20,0	19,8	19,5	20,2	19,9	20,4	20,0	19,5	20,0	20,5	20,0	19,8	19,5	21,2	20,2	19,6	21,1	20,0
21,9	23,2	24,0	22,2	21,7	24,0	23,4	23,6	23,9	22,4	22,2	23,7	23,9	21,8	22,0	23,9	21,0	22,4	24,2	23,0
			20,9	21,1									21,1	21,5			21,9		
			20,5	20,6									20,6	20,9			21,5		
			23,2	24,2									23,5	24,3			23,5		
18,5	18,5	18,5	18,8	18,5	18,5	19,0	18,4	18,2	18,7	18,8	18,4	18,2	18,5	18,0	20,0	18,5	18,5	19,8	18,5
17,5	18,0	18,0	18,5	18,0	18,0	18,5	18,5	18,0	18,5	18,5	17,2	18,0	18,0	17,5	20,0	18,5	18,0	19,5	18,0
19,7	21,5	21,5	21,6	20,1	21,7	21,3	21,7	21,4	21,1	20,9	21,2	21,4	20,2	21,0	21,8	20,4	20,6	22,5	21,0
14,9	14,8	14,7	14,6	14,7	14,8	14,8	14,8	15,0	14,9	14,5	14,5	15,0	14,6	14,4		15,0	14,9	15,4	14,7
13,0	13,2	12,9	13,5	13,0	12,8	13,1	13,0	13,0	13,1	12,6	13,1	13,0	12,8	12,8	14,2	13,0	13,2	14,4	13,3
														12,1					
10,7	10,2	10,9	11,0	10,6	11,0	10,7	10,9	10,9	10,7	11,0	11,0	10,9	10,7	10,8	12,5	10,8	10,2	13,0	11,0
14,8	15,1	14,9	15,0	14,9	14,5	15,1	14,9	14,8	15,0	14,6	14,6	14,8	15,0	15,0	15,4	15,3	15,0	16,1	14,7
16,7	17,0	16,7	16,8	16,5	16,8	16,8	16,4	16,3	16,7	17,0	16,6	16,3	16,8	16,8	18,0	16,8	16,0	19,8	17,0
14,2	14,5	13,9		14,0					14,3		14,2		14,0	14,3		14,6	14,5		
18,7	18,5	18,7	18,5	18,3			18,5		18,2		17,0		18,1	18,2	18,0	19,1	19,0	19,7	
14,6	14,7	14,5	14,5	14,4				14,6	14,8	14,5	14,5	14,6	14,4	14,3	16,0	14,8	14,8	15,3	13,8
21,5	20,5	21,0	22,0	21,5	21,5		21,5	21,5	22,0	21,0	21,7	21,5	20,5	21,0	23,0	21,0	22,0	23,0	20,5
17,1	17,9	17,5	18,0	17,1	17,5		17,8	18,1	18,2	18,6	17,9	18,1	17,6	17,4	19,5	18,2	17,9	21,4	17,9
18,5	18,2	18,1	18,6	18,2	18,2		18,3	18,1	18,3	18,5	18,5	18,1	18,3		20,2		18,2	21,9	18,4
17,9	18,5	18,4	18,1	18,2					18,3		18,0		18,7	18,4	22,5		18,5	21,5	
16,7	17,0	16,7	16,8	16,5	16,8	16,8	16,4	16,3	16,7	17,0	16,6	16,3	16,8	16,8	18,0	16,8	16,0	19,8	17,0
22,5	22,2	22,1	22,0	22,0	22,3	22,3	22,5	22,5	21,7		22,8	22,5	22,0	22,0	22,3	22,7		22,8	
	22,2				22,3							22,5			22,3				
15,1	15,3	17,1	15,0	14,8	15,2	15,2	15,1	15,1	15,0	15,3	15,0	15,1	15,0	15,0		15,4	15,6	16,0	15,2
19,3	20,5	19,3	20,2	20,0	20,3	19,4	20,2	19,8	19,2	20,2	21,0	19,8	19,0	18,9	20,2	20,5	20,0	25,0	20,2
20,5	20,0	20,5	20,4	20,0	24,0	20,3	20,5	20,3	19,8	20,5	22,0	20,3	20,0	19,5	20,5	21,5	18,2	20,0	
28,9	29,3	29,0	29,1	28,3	27,5	28,8	27,8	27,9	28,9	28,7	31,0	27,9	29,0	30,2	29,2	29,5	29,1	28,2	28,6
21,5	21,5	21,4	21,6	21,5	21,3	21,4	23,2	22,9	21,3	21,9	23,0	22,9	21,5	22,4	26,3	21,5	21,8	25,7	21,8
17,6	18,1	18,0	18,5	17,8	18,2	17,8	17,7	18,6	17,9	18,5	18,2	18,6	18,0	17,6	18,9	18,0	18,3	18,9	17,2
14,9	15,1	15,0	15,1	15,1		14,9			14,8	15,0	15,0		14,8	15,1		15,1	14,9		15,0
16,6	16,8			16,6		16,6			16,2	17,9	18,0		16,4	23,6		16,7	26,0		18,7
22,6	22,6	21,5	22,8	22,6	21,5	23,0	22,0	22,3	23,0	23,5	22,0	22,3	22,5	21,1	26,0	22,6	22,8	24,6	23,7
22,9	23,1	22,1	23,5	23,3	26,2	23,1	23,0	23,2	23,0	24,1	21,9	23,2	23,2	22,0	26,7	22,7	23,1	24,8	24,6
22,6	23,0	22,1	23,1	23,0	22,1	23,1	23,0	23,1	23,0	24,1	22,2	23,1	22,6	22,0		22,7	22,7	27,1	24,0
17,3	15,2			17,5		15,1			17,5				17,6	16,7		17,2	17,5		
16,7	14,5			17,2		14,9			17,0				17,3	16,2		16,8	17,0		
18,7	17,0			19,5		16,8			19,6				18,5	18,6		18,3	19,0		
19,5	20,0	24,5	22,9	20,0	24,5	20,3	23,0	23,0	20,0	19,5	21,9	23,0	24,5	21,5	30,0	20,0	19,5	30,0	20,5
17,5	19,0	18,5	19,5	18,5	18,5	18,5	18,5	19,5	18,5	18,5	18,5	19,5	18,5	18,0		18,0	18,0		18,0
26,0	27,1	26,1	25,9	27,0	26,2	26,9	26,4	26,3	20,9	27,9	26,3	26,3	26,5	26,1	26,3	26,8	27,1	27,2	27,7
											26,5								
15,1	15,3	17,1	15,0	14,8	15,2	15,2	15,1	15,1	15,0	15,3	15,0	15,1	15,0	15,0		15,4	15,6	16,0	15,2
											11,5		10,0	12,0		12,0	11,0		
19,5	20,0	24,5	22,9	20,0	24,5	20,3	23,0	23,0	20,0	19,5	21,9	23,0	24,5	21,5	30,0	20,0	19,5	30,0	20,5
19,5	20,0	20,0	22,9	20,0	24,5		23,0	23,0	20,0	20,0	21,9	23,0	24,5	21,5	30,0	20,0	19,5	30,5	20,0
17,5	19,0	18,5	19,5	18,5	18,5	18,5	18,5	19,5	18,5	13,5	18,5	19,5	18,5	18,0		18,0	18,0		18,0
17,7	18,6	18,5	19,2	18,4	18,5	18,5	18,9	19,6	18,5	18,1	18,5	19,6	18,4	18,0		17,7	17,8	28,2	17,9
18,0	17,0	17,0	17,5	17,4	16,5	17,1	17,1	17,0	17,6	17,5	17,0	17,0	18,0	16,2	18,0	18,0	18,0	20,5	17,0
5,5	5,5	5,9	5,7	5,6		5,5	5,5	5,5	5,5	5,8	5,5	5,5	5,3	5,0	5,8	5,5	5,5		4,9
21,8	21,6	22,1	21,9	22,1	22,2	21,3	21,0	22,0	21,9	22,5	22,0	22,0	21,4	21,8	27,0	22,5	21,6	27,5	
28,8	28,9	27,8	28,2	28,9	28,5	29,1	28,7	28,8	28,9	29,2	38,0	28,8	30,9	32,8	29,9	30,5	28,9	30,5	27,9
23,2	23,5	24,0	23,4	23,2	23,9	23,3	23,6	23,8	23,5	23,4	24,5	23,8	23,2	24,5	25,6	23,4	23,4	25,7	23,5
25,1	26,2	24,0	25,6	25,2	25,6	25,6	25,1	26,0	25,3	23,9	25,8	26,0	23,5	26,3	28,2	26,7	25,1	28,1	28,2
25,3	25,0	32,5	25,1	24,7	31,8	25,2	29,8	29,3	24,4	25,2	25,5	29,3	32,0	24,7	31,8	25,5	25,3	31,5	32,3
	25,0				31,8							29,3			31,8				
23,0	22,5	27,0	22,5	22,0	27,5	22,5	25,0	25,0	22,0	22,5	29,3	25,0	27,0	21,5	28,0	23,0	23,0	28,0	28,0
	22,5				27,5							25,0			28,0				
12,5	13,0	12,2	12,2	12,3	12,0	12,9	12,6	12,6	12,2	12,7	15,0	12,6	12,0	13,0	16,0	13,0	12,8	14,0	13,9
9,2	9,5	9,5	9,5	9,3	11,9	9,7	9,6	9,6	9,4	10,0	9,5	9,6	9,4	9,5	9,5	9,2	9,3	9,5	11,6

Gilding*   Dorure*   Baño* Verguld*   Doratura*		Complete Gilding Dorure totale Baño completo Geheel verguld Doratura completa		Partial Gilding Dorure de décor Con adorno bañado en oro Decorvergulding Con i particolari oro	
		👑 925 Sterling Silver	🐘 150 massive silver plated	👑 925 Sterling Silver	🐘 150 massive silver plated
Art. No.   Art. Nr.   Ref.   Art.-Nr.   Art. no.					
004	Menu spoon   Cuiller à menu   Cuchara mesa   Tafellepel   Cucchiaio tavola	413,-	210,-	386,-	183,-
005	Menu fork   Fourchette à menu   Tenedor mesa   Tafelvork   Forchetta tavola	386,-	183,-	386,-	183,-
006	Menu knife   Couteau à menu   Cuchillo mesa   Tafelmes   Coltello tavola	356,-	221,-	346,-	211,-
106	Menu knife   Couteau à menu   Cuchillo mesa   Tafelmes   Coltello tavola – Frozen Black	396,-	261,-	386,-	251,-
001	Table spoon   Cuiller de table   Cuchara banquete   Tafellepel, groot   Cucchiaio tavola, grande	426,-	219,-	398,-	191,-
002	Table fork   Fourchette de table   Tenedor banquete   Tafelvork, groot   Forchetta tavola, grande	396,-	189,-	398,-	191,-
003	Table knife   Couteau de table   Cuchillo banquete   Tafelmes, groot   Coltello tavola, grande	379,-	231,-	371,-	223,-
007	Dessert spoon   Cuiller à dessert   Cuchara postre/entremés   Dessertlepel   Cucchiaio frutta	369,-	193,-	356,-	180,-
008	Dessert fork   Fourchette à dessert   Tenedor postre/entremés   Dessertvork   Forchetta frutta	350,-	174,-	356,-	180,-
009	Dessert knife   Couteau à dessert   Cuchillo postre/entremés   Dessertmes   Coltello frutta	329,-	210,-	326,-	207,-
020	Coffee spoon, large   Cuiller à café, grande   Cuchara café, grande   Koffielepel, groot   Cucchiaio tè e colazione	242,-	150,-	250,-	158,-
021	Coffee spoon   Cuiller à café   Cuchara café   Koffielepel   Cucchiaio caffè-tè	217,-	142,-	227,-	152,-
022	Tea spoon III   Cuiller à thé   Cuchara té   Theelepelle III   Cucchiaio tè	186,-	123,-	200,-	137,-
023	Mocha-/espresso spoon   Cuiller à moka   Cuchara moca   Mokka-/Espresso lepel   Cucchiaio moca/espresso	164,-	106,-	188,-	130,-
027	Cake fork, large   Fourchette à gâteaux, grande   Tenedor tarta   Taartvorkje   Forchetta dolci	251,-	148,-	257,-	154,-
068	Cake knife   Couteau à gâteaux   Cuchillo tarta   Fruitmesje = Taartmesje   Coltello dolci	280,-	196,-	288,-	204,-
028	Oyster fork   Fourchette à huîtres   Tenedor ostras   Oestervork   Forchetta ostriche	327,-	191,-	335,-	199,-
083	Butter spreader   Tartineur   Cuchillo de mantequilla   Boterspreider   Coltello burro	294,-	210,-	291,-	207,-
026	Ice-cream spoon   Cuiller à glace   Cuchara helado   Ijslepel = Puddinglepel   Cucchiaio gelato	242,-	150,-	256,-	164,-
010	Fish knife   Couteau à poisson   Cuchillo pescado   Vismes   Coltello pesce	407,-	187,-	409,-	189,-
011	Fish fork   Fourchette à poisson   Tenedor pescado   Visvork   Forchetta pesce	403,-	183,-	409,-	189,-
097	Gourmet spoon   Cuiller gourmet   Cuchara gourmet   Gourmetlepel   Cucchiaio salsa individuelle	422,-	202,-	409,-	189,-
029	Lobster fork   Fourchette à homard   Tenedor de marisco   Kreeftvork   Forchetta aragosta	365,-	188,-	392,-	215,-
068	Fruit knife   Couteau à fruits   Cuchillo fruta   Fruitmes (Taartmesje)   Coltello dolci	280,-	196,-	288,-	204,-
084	Steak knife   Couteau à steak   Cuchillo steak   Steakmes   Coltello bistecca	370,-	233,-	361,-	223,-
184	Steak knife   Couteau à steak   Cuchillo steak   Steakmes   Coltello bistecca – Frozen Black	398,-	261,-	389,-	251,-
025	Broth spoon   Cuiller à consommé   Cuchara taza   Bouillonlepel/Roomlepel   Cucchiaio brodo/panna	357,-	176,-	352,-	171,-
091/092	Butter/cheese knife   Couteau à beurre et à fromage   Cubierto de mantequilla y queso   B.- en Kaasmesje   Coltello burro/formaggio	644,-	438,-	650,-	444,-
045/046	Fish serving knife and fork   Service à poisson   Cubierto servir pescado   Visdiencouvert   Coltello e forch. servire pesce	1.718,-	794,-	1.662,-	738,-
031	Meat fork, large   Fourchette à viande, grande   Tenedor carne, grande   Vleesdienvork, groot   Forchetta carne, grande	358,-	193,-	356,-	191,-
032	Meat fork, small   dito, petite   ídem, pequeño   Vleesdienvork, klein   Forchetta carne, piccola	293,-	171,-	297,-	175,-
050	Pastry server   Pelle à gâteaux   Pala bizcocho   Gebakschep   Pala dolci	472,-	235,-	458,-	221,-
038	Vegetable fork   Fourchette à légumes   Tenedor verdura   Dienvork   Forchetta legumi	838,-	391,-	810,-	363,-
033	Vegetable server   Cuiller à légumes   Cuchara verdura   Groentelepel   Cucchiaio legumi	838,-	382,-	810,-	354,-
034	Potato server   Cuiller à pommes de terre   Cuchara patatas   Aardappellepel   Cucchiaio patate	838,-	382,-	810,-	354,-
014	Children's spoon   Cuiller pour enfants   Cuchara infantil   Kinderlepel   Cucchiaio per bambini	263,-	156,-	260,-	153,-
015	Children's fork   Fourchette pour enfants   Tenedor infantil   Kindervork   Forchetta per bambini	253,-	146,-	260,-	153,-
016	Children's knife   Couteau pour enfants   Cuchillo infantil   Kindermes   Coltello per bambini	294,-	210,-	289,-	205,-
040	Compote spoon, large   Cuiller à entremets, grande   Cuchara compota, grande   Puddingschep, groot   Cucchiaio serv. insalata, gr.	824,-	368,-	818,-	362,-
042	Compote spoon, small   dito, petite   ídem, pequeña   Puddingschep, klein   Cucchiaio serv. insalata, picc.	483,-	262,-	499,-	278,-
044	Serving spoon, large   Cuiller à servir, grande   Cuchara servir   Dienlepel, groot   Cucchiaio servire, gr.	1.011,-	454,-	935,-	378,-
086	Pierced Spoon   Cuillère percée   Espumadera   Opengewerkt lepel   Schiumarola	1.011,-	454,-	935,-	378,-
025	Cream spoon   Cuiller à crème   Cuchara nata   Slagroomlepel   Cucchiaio brodo/panna	357,-	176,-	352,-	171,-
061	Cream spoon, bent   Cuiller à crème, cintrée   Cuchara nata, curvada   Slagroomlepel, gebogen   Cucchiaio panna, piegato	298,-	153,-	312,-	167,-
040/041	Salad serving set, large   Service à salade, grande   Cubierto ensalada, grande   Saladecouvert, groot   Cucch. e forch. serv. ins., gr.	1.648,-	736,-	1.636,-	724,-
042/043	Salad serving set, small   dito, petite   ídem, pequeño   Saladecouvert, klein   Cucch. e forch. serv. ins., picc.	966,-	524,-	998,-	556,-
035	Sauce ladle   Cuiller à sauce   Cuchara salsa   Sauslepel   Cucchiaio salsa	688,-	372,-	665,-	349,-
019	Table napkin ring   Rond de serviette   Servilletero   Servetring   Portatovagliolo	363,-	202,-	386,-	225,-
047	Asparagus server/tongs   Pelle/pince à asperges   Pala/pinzas para espárragos   Aspergeschep/-tang   Paletta/Pinza per asparagi	1.190,-	592,-	1.127,-	529,-
036	Soup ladle   Louche   Cazo sopa   Soeplepel   Mestolo	1.414,-	656,-	1.317,-	559,-
052	Tart server   Pelle à tarte   Pala tarta   Taartschep   Pala torta	666,-	327,-	641,-	302,-
054	Tart knife   Couteau à tarte   Cuchillo tarta   Taartmes   Coltello torta	422,-	299,-	428,-	305,-
048/049	Carving knife and fork   Service à découper   Cubierto trinchar   Trancheercouvert   Coltello e forchetta trinciante	954,-	658,-	970,-	674,-
148/149	Carving knife and fork   Service à découper   Cubierto trinchar   Trancheercouvert   Coltello e forchetta trinciante – Frozen Black	1.084,-	788,-	1.100,-	804,-
064	Sugar spoon   Cuiller à sucre   Cucharilla azúcar   Suikerlepel   Cucchiaio zucchero	238,-	146,-	248,-	156,-
065	Sugar tongs   Pince à sucre   Pinzas azúcar   Suikertang   Pinza zucchero	297,-	170,-	337,-	210,-

Partial Gilding Dorure de décor Con adorno bañado en oro Decorvergulding Con i particolari oro	
Alt-Chippendale	
Arcade	
Art Deco	
Avenue	
Belvedere	
Classic-Faden	
Französisch-Perl	
Gio	
Hermitage	
Ostfriesen	
Rosenmuster	

REPARATION   RÉPARATIONS REPARACIONES   REPARATIES   RIPARAZIONE	
	from à partir de vanaf   del dal EURO
New blade – knife incl. insertion and polishing Nouvelle lame – échange et polissage Nueva hoja de cuchillo incl. la labor de engaste Nieuw lemmet – bij menumes en kleiner incl. inzetten Nuovo lama per coltello, compreso l'incastro	37,-
New blade – insertion and complete reworking of the knife Nouvelle lame – échange et retravailler du couteau Nueva hoja – la labor de engaste e il ritrattamento del coltello Nieuw lemmet – inzetten en het opknappen van het mes Nuovo lama – compreso l'incastro y el reacondicionamiento de cuchillo	68,-
New blade – tart knife/carving knife – incl. insertion and polishing Nouvelle lame – couteau à tarte/couteau à découper – échange et polissage Nueva hoja – cuchillo torta/cuchillo trinchar incl. la labor de engaste Nieuw lemmet – taartmes/trancheermes inzetten Nuovo lama – coltello torta/coltello trinciante, compreso l'incastro	50,-
New blade – tart knife/carving knife – insertion and complete reworking Nouvelle lame – couteau à tarte/couteau à découper – échange et retravailler Nueva hoja – cuchillo torta/cuchillo trinchar – la labor de engaste e il ritrattamento Nieuw lemmet – taartmes/trancheermes – inzetten en het opknappen van het mes Nuovo lama – coltello torta/coltello trinciante – compreso l'incastro y el reacondicionamiento	80,-
Polishing of blade Polissage d'une lame Pulir la hoja Lemmet polijsten Lucidare della lama	9,-
Serration of blade Transformation en lame-scie Poner sierra a la hoja Lemmet voorzien van kartel Aggiungere lama con sega	8,-
Removing of serration and polishing of blade Enlever la scie et aiguisage de lame Retirar la sierra y afilar la hoja Kartel verwijderen en lemmet slijpen Rimuovere della sega e la rettifica della lama	12,-
Finishing (Grinding/pre-polishing/electro-plating/polishing) Remise en état (aiguisage, polissage, argenter) Reacondicionar (afilarse/pulir/baño plata/repulir) Opwerken (slijpen/polijsten/verzilveren/haplijsten) Finire (Rettificare, pulire, argentare, lucidare)	40,-
Table / menu / dessert size Pièces en taille table/menu/dessert Tamaño de la mesa, del menú y del postre Tafel- / menu- / dessertgrootte Tabella- / menu- / dimensione del dessert	26,-
Cutlery pieces smaller than dessert size Pièces plus petites que la taille dessert Piezas de cubiertos más pequeñas que el tamaño del postre Bestekstukken kleiner dan dessertgrootte Pezzi di posate più piccoli del formato del dessert	61,-
Serving pieces Pièces à servir Piezas de servir Dienbestek Posate da servire	102,-
Soup ladle, asparagus server, serving spoon Louche, pelle/pince à asperges, cuiller à servir Cucharón de sopa, pala de espárgamos, cuchara de servicio Soeplepel, aspergeschep, dienlepel Mestolo da zuppa, pala per asparagi, cucchiaio da portata	12,-
1 piece of cutlery, only polishing Polissage de couverts par pièce pulido de cubiertos, por pieza 1 Bestekdeel alleen polijsten 1 pezzo singolo, solo lucidare	12,-

SETS   GARNITURES   ADORNOS   SETS   SERVIZI		Piece set   Service à menu   Cubertería de mesa Tafelbestek   Posto tavola										
		9	24	30	39	69	69 NL	75	110	128	133	185
004	Menu spoon   Cuiller à menu   Cuchara mesa   Tafellepel   Cucchiaio tavola		6	6	6	12	6	12	12	12	12	12
005	Menu fork   Fourchette à menu   Tenedor mesa   Tafelvork   Forchetta tavola		6	6	6	12	6	12	12	12	12	12
006	Menu knife   Couteau à menu   Cuchillo mesa   Tafelmes   Coltello tavola		6	6	6	12	6	12	12	12	12	12
001	Table spoon   Cuiller de table   Cuchara banquete   Tafellepel, groot   Cucchiaio tavola, grande											
002	Table fork   Fourchette de table   Tenedor banquete   Tafelvork, groot   Forchetta tavola, grande											
003	Table knife   Couteau de table   Cuchillo banquete   Tafelmes, groot   Coltello tavola, grande											
007	Dessert spoon   Cuiller à dessert   Cuchara postre/entremés   Dessertlepel   Cucchiaio frutta					6		12	12	12	12	12
008	Dessert fork   Fourchette à dessert   Tenedor postre/entremés   Dessertvork   Forchetta frutta					6	12	12	12	12	12	12
009	Dessert knife   Couteau à dessert   Cuchillo postre/entremés   Dessertmes   Coltello frutta					6	12	12	12	12	12	12
020	Coffee spoon, large   Cuiller à café, grande   Cuchara café, grande   Koffielepel, groot   Cucchiaio tè e colazione											
021	Coffee spoon   Cuiller à café   Cuchara café   Koffielepel   Cucchiaio caffè-tè		6	6	6	12	12	12	12	12	12	12
022	Tea spoon III   Cuiller à thé   Cuchara té   Theelep III   Cucchiaio tè											
023	Mocha-/espresso spoon   Cuiller à moka   Cuchara moka   Mokka-/Espressolepel   Cucchiaio moca/espresso											12
027	Cake fork, large   Fourchette à gâteaux, grande   Tenedor tarta   Taartvorkje   Forchetta dolci			6	6	12	12			12	12	12
069	Cake fork   Fourchette à gâteaux, petite   Tenedor tarta, pequeño   Fruitvorkje = Taartvorkje   Forchetta dolci, piccola											
068	Cake knife   Couteau à gâteaux   Cuchillo tarta   Fruitmesje = Taartmesje   Coltello dolci											
028	Oyster fork   Fourchette à huîtres   Tenedor ostras   Oestervork   Forchetta ostriche											
083	Butter spreader   Tartineur   Cuchillo de mantequilla   Boterspreider   Coltello burro											
026	Ice-cream spoon   Cuiller à glace   Cuchara helado   Ijslepel = Puddinglepel   Cucchiaio gelato											12
010	Fish knife   Couteau à poisson   Cuchillo pescado   Vismes   Coltello pesce							12	12	12	12	12
011	Fish fork   Fourchette à poisson   Tenedor pescado   Visvork   Forchetta pesce							12	12	12	12	12
097	Gourmet spoon   Cuiller gourmet   Cuchara gourmet   Gourmetlepel   Cucchiaio salsa individuale											
029	Lobster fork   Fourchette à homard   Tenedor de marisco   Kreeftenvork   Forchetta aragosta											
069	Fruit fork   Fourchette à fruits   Tenedor fruta   Fruitvorkje (Taartvorkje, klein)   Forchetta dolci, piccola											
068	Fruit knife   Couteau à fruits   Cuchillo fruta   Fruitmes (Taartmesje)   Coltello dolci											
084	Steak knife   Couteau à steak   Cuchillo steak   Steakmes   Coltello bistecca											
025	Broth spoon   Cuiller à consommé   Cuchara taza   Bouillonlepel/Roomlepel   Cucchiaio brodo/panna											12
030	Meat serving fork   Fourchette à rôtis   Tenedor asado   Vleesdienvork   Forchetta arrosto											
091/092	Butter/cheese knife   Couteau à beurre et à fromage   Cubierto de mantequilla y queso   B.- en Kaasmesje   Coltello burro/formaggio										1	2
045/046	Fish serving knife and fork   Service à poisson   Cubierto servir pescado   Visdiencouvert   Coltello e forch. servire pesce											1
031	Meat fork, large   Fourchette à viande, grande   Tenedor carne, grande   Vleesdienvork, groot   Forchetta carne, grande		2		2	2	1				2	4
032	Meat fork, small   dito, petite   idem, pequeño   Vleesdienvork, klein   Forchetta carne, piccola											
050	Pastry server   Pelle à gâteaux   Pala bizcocho   Gebakschep   Pala dolci											
038	Vegetable fork   Fourchette à légumes   Tenedor verdura   Dienvork   Forchetta legumi		1		1	1	1	1	1	1	1	2
033	Vegetable server   Cuiller à légumes   Cuchara verdura   Groentelep   Cucchiaio legumi		1		1	1	1	1	1	1	1	2
034	Potato server   Cuiller à pommes de terre   Cuchara patatas   Aardappellepel   Cucchiaio patate											
014	Children's spoon   Cuiller pour enfants   Cuchara infantil   Kinderlepel   Cucchiaio per bambini											
015	Children's fork   Fourchette pour enfants   Tenedor infantil   Kindervork   Forchetta per bambini											
016	Children's knife   Couteau pour enfants   Cuchillo infantil   Kindermes   Coltello per bambini											
040	Compote spoon, large   Cuiller à entremets, grande   Cuchara compota, grande   Puddingschep, groot   Cucchiaio serv. insalata, gr.						1					
042	Compote spoon, small   dito, petite   idem, pequeña   Puddingschep, klein   Cucchiaio serv. insalata, picc.											
044	Serving spoon, large   Cuiller à servir, grande   Cuchara servir   Dienlepel, groot   Cucchiaio servire, gr.		1		1	1						
025	Cream spoon   Cuiller à crème   Cuchara nata   Slagroomlepel   Cucchiaio brodo/panna		1		1	1	1				1	
061	Cream spoon, bent   Cuiller à crème, cintrée   Cuchara nata, curvada   Slagroomlepel, gebogen   Cucchiaio panna, piegato											
040/041	Salad serving set, large   Service à salade, grande   Cubierto ensalada, grande   Saladecouvert, groot   Cucch. e forch. serv. ins., gr.									1	1	2
042/043	Salad serving set, small   dito, petite   idem, pequeño   Saladecouvert, klein   Cucch. e forch. serv. ins., picc.											
035	Sauce ladle   Cuiller à sauce   Cuchara salsa   Sauslepel   Cucchiaio salsa		1		1	1	1			1	1	2
019	Table napkin ring   Rond de serviette   Servilletero   Servetring   Portatovagliolo											
047	Asparagus server/tongs   Pelle/pince à asperges   Pala/pinzas para espárragos   Aspergeschep/-tang   Paletta/Pinza per asparagi											
036	Soup ladle   Louche   Cazo sopa   Soeplepel   Mestolo					1	1		1	1	1	
052	Tart server   Pelle à tarte   Pala tarta   Taartschep   Pala torta		1		1	1	1			1	1	2
054	Tart knife   Couteau à tarte   Cuchillo tarta   Taartmes   Coltello torta											2
048/049	Carving knife and fork   Service à découper   Cubierto trincar   Trancheercouvert   Coltello e forchetta trinciante											1
064	Sugar spoon   Cuiller à sucre   Cucharilla azúcar   Suikerlepel   Cucchiaio zucchero		1		1	1	1				1	
065	Sugar tongs   Pince à sucre   Pinzas azúcar   Suikertang   Pinza zucchero									1		2

Napkin rings | Ronds de serviette | Servilleteros | Servetringen | Portatovaglioli

12. Alta, Riva



👑 925 EURO 284,- 🐘 150 EURO 123,-

Alt-Chippendale, Navette

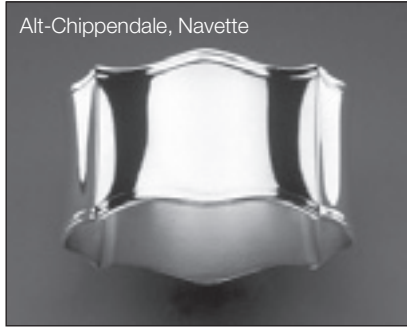

👑 925 EURO 284,- 🐘 150 EURO 123,-

Alt-Faden



👑 925 EURO 284,- 🐘 150 EURO 123,-

Alt-Kopenhagen



👑 925 EURO 284,- 🐘 150 EURO 123,-

Alt-Spaten, Spaten, Dante, Eclipse



👑 925 EURO 284,- 🐘 150 EURO 123,-

Arcade



👑 925 EURO 284,- 🐘 150 EURO 123,-

Art Deco



👑 925 EURO 284,- 🐘 150 EURO 123,-

Avenue

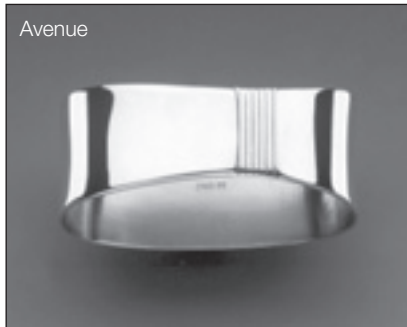

👑 925 EURO 284,- 🐘 150 EURO 123,-

Classic-Faden



👑 925 EURO 284,- 🐘 150 EURO 123,-

Französisch-Perl



👑 925 EURO 284,- 🐘 150 EURO 123,-

Gio



👑 925 EURO 284,- 🐘 150 EURO 123,-

Hermitage/Martelé



👑 925 EURO 284,- 🐘 150 EURO 123,-

Ostfriesen



👑 925 EURO 284,- 🐘 150 EURO 123,-

Rosenmuster







👑 925 EURO 284,- 🐘 150 EURO 123,-

Sphinx



👑 925 EURO 284,-

Children's Sets   Couverts pour enfants Cubiertos para niños   Kindercouverts   Posate per bambini Annual spoon   Cuiller annuelle   Cuchara anual   Jaarlepel   Cucchiaino dell'anno		925 Sterling Silver EURO	150 massive silver plated EURO
		Child set, 3 pcs.   Couvert pour enfants, 3 pcs. Cubierto para niño, 3 piezas.   3dlg. Kindercouvert Posate per bambini, 3 pezzi.  Alta, Alt-Chippendale, Alt-Faden, Alt-Kopenhagen, Alt-Spaten, Avenue, Classic-Faden, Französisch-Perl, Navette, Ostfriesen, Rosenmuster, Spaten	568,- 270,-
		Child set, 4 pcs.   Couvert pour enfants, 4 pcs. Cubierto para niño, 4 piezas.   4dlg. Kindercouvert Posate per bambini, 4 pezzi.  Alta  Alt-Chippendale, Alt-Faden, Alt-Kopenhagen, Alt-Spaten, Avenue, Classic-Faden, Französisch-Perl, Navette, Ostfriesen, Rosenmuster, Spaten	684,- 328,- 719,- 346,-
		Child's cup + spoon Gobelet pour enfants + cuiller Taza niños + cucharilla Kinderbeker + Lepeltje Bicchieri per bambini + cucchiaino  Alt-Spaten, Alt-Chippendale, Classic-Faden  Alta  Child's cup 90 g silver plated   Timbale pour enfants argentée, éclat dur chargé à 90 g   Taza niños 90 g 90 baño de plata Kinderbeker 90 g verzilverd   Bicchieri per bambini argentatura 90 g See for children's cups on page 41.   Prix de la timbale enfant (p. 41) Para conocer el precio de los vasos infantiles (p. 41) Prijs voor kinderbekers (p. 41)   Prezzo per bicchiere per bambino (p. 41)	831,- 360,- 796,- 342,-
		Baby set, 2 pcs.   Couvert pour bébé, 2 pcs. Juego bebé, 2 piezas.   2dlg. Babybestek Posate per neonato, 2 pezzi.  Spaten	488,- 192,-
		Birth spoon   Cuiller de naissance Cuchara de nacimiento   Geboortelepел Cucchiaino per la nascita  Boy Garçon Niño Jongen Maschietto  Girl Fille Niña Meisje Femminuccia  Signature   Gravure   Grabados   Gravure   Incisione 17,-	202,- 99,- 51403001 51402001  202,- 99,- 51403002 51402002
		Book-marker   Signet Marcapáginas   Bladwijzer   Segnalibro ♂ ♀  Mocha pot   cafetière à moka cafetara   Moccapot   Caffettiera da moca  Heart   Coeur Corazón   Hart   Cuore	84,- - 50403001 - 84,- - 50403002 - 68,- - 50403005 - 124,- - 50403003 -



Gourmet collection | Collection gourmet  
Colección gourmet | Gourmet collectie | Collezione gourmet

925  
Sterling  
Silver  
EURO

150  
massive  
silver  
plated  
EURO

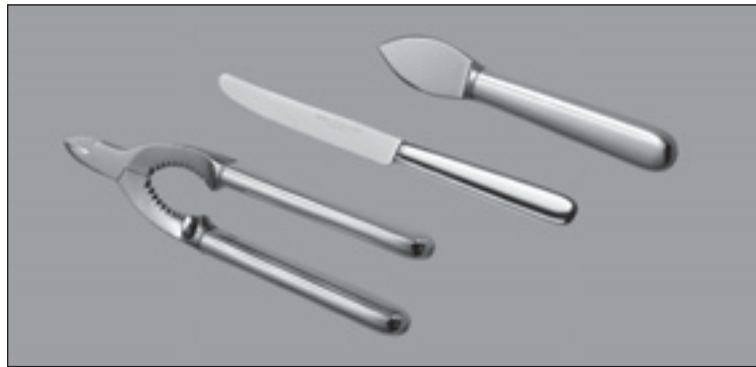

Parmesanknife  
Cuchillo parmesano  
Coltello per parmigiano

Tomato knife  
Cuchillo de tomate  
Coltello per pomodori

Champagne tongs  
Abridor champán  
Apribottiglia Champagne

Couteau à parmesan  
Parmezaanmes

Couteau à tomates  
Tomatenmes

Pince à champagne  
Champagneopener

221,-  
06203312

174,-  
06203378

477,-  
06203313

124,-  
06202312

124,-  
06202378

262,-  
06202313

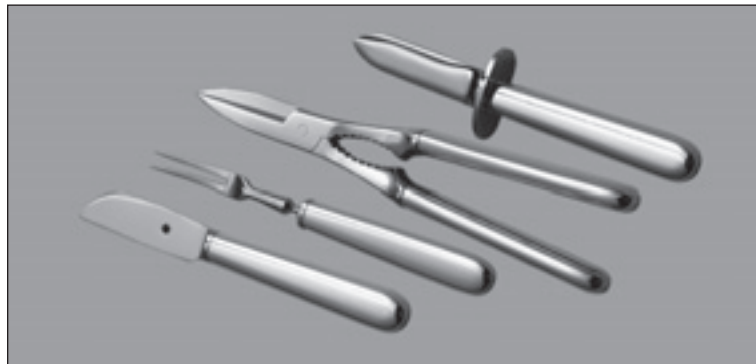

Oyster knife  
Cuchillo de ostras  
Coltello per ostriche

Lobster tongs  
Tenazas langosta  
Pinza per astice

Escargot fork  
Tenedor caracoles  
Forchetta per lumache

Crab knife  
Cuchillo cangrejo  
Coltello per gamberi

Couteau à huîtres  
Oestermes

Pince à crustacés  
Kreeftentang

Fourchette à escargot  
Slakkenvork

Couteau à écrevisse  
Krabmes

235,-  
06203376

477,-  
06203357

175,-  
06203390

235,-  
06203389

131,-  
06202376

297,-  
06202357

124,-  
06202390

127,-  
06202389

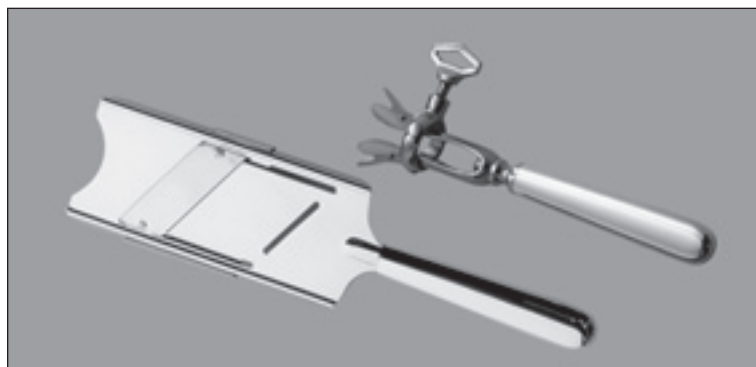

Drumstick clamp, large  
Agarrador muslitos  
Pinza per gigot

Drumstick clamp, small  
Pince à cuisse de caille  
Soporte de muslos de codorniz  
Kwartelbotklem  
Pinza per piccione  
(without fig. | sans photo | sin ilustración | z. afb. | senza fig.)

Truffle slicer  
Cortador trufa  
Affetta tartufo

Pince à gigot  
Botklem

Rape à truffes  
Truffelmes

357,-  
06203388

237,-  
06203387

330,-  
06203382

233,-  
06202388

184,-  
06202387

197,-  
06202382

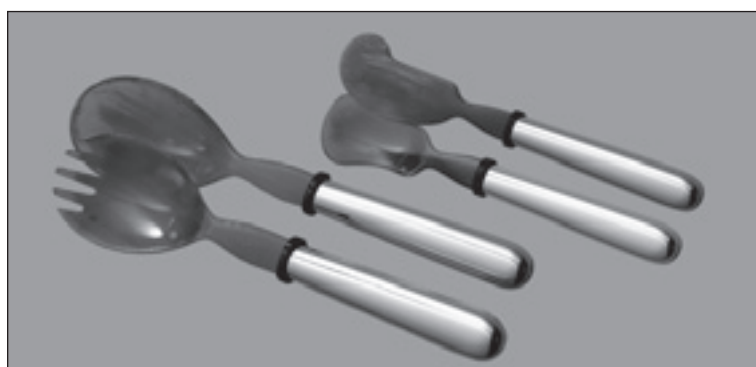

Caviar spoon  
Cuchara caviar  
Cucchiaio per caviale

Caviar knife  
Cuchillo caviar  
Coltello per caviale

Salad spoon  
Cuchara ensalada  
Cucchiaio da insalata

Salad fork  
Tenedor ensalada  
Forchetta per insalata

Cuiller à caviar  
Kaviaarlepel

Couteau à caviar  
Kaviaarmes

Cuiller à salade  
Saladelepel

Fourchette à salade  
Saladevork

290,-  
06203380

290,-  
06203381

342,-  
06203355

342,-  
06203356

231,-  
06202380

231,-  
06202381

250,-  
06202355

250,-  
06202356

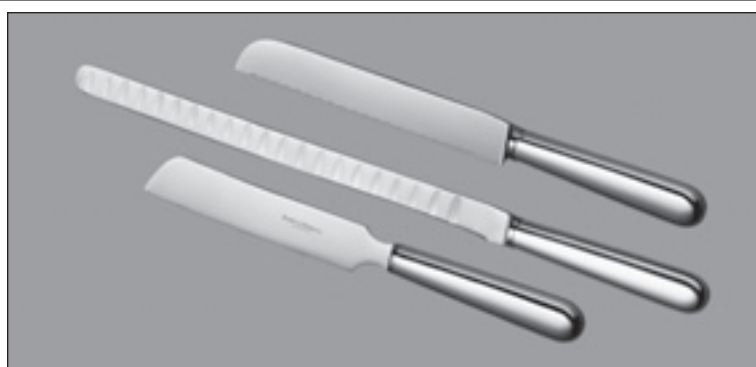

Bread knife  
Cuchillo de pan  
Coltello pane

Salmon carvin knife  
Couteau à découper le saumon  
Cuchillo de salmón  
Zalmmes  
Coltello salmone

Cake knife  
Cuchillo de tarta  
Coltello torta

Couteau à pain  
Broodzaag

Couteau à cake  
Cakemes

305,-  
06203379

330,-  
06203359

305,-  
06203393

175,-  
06202379

203,-  
06202359

175,-  
06202393

Stainless steel cutlery  
Couverts acier massif  
Cuberterías acero inoxidable  
Edelstalen bestekken 18  
Reposate Inox 18/8



Atlantic-Brillant



Atlantic\*

EURO

058.06

052.06

3-pc. children's set   Couvert pour enfants à 3 pcs.   3 pz. Set infantil   3dlg. Kindercouvert   Posate per bambini, 3 pos.	99,-		
4-pc. children's set   Couvert pour enfants à 4 pcs.   4 pz. Set infantil   4dlg. Kindercouvert   Posate per bambini, 4 pos.	124,-		
24-piece set   Service à Menu 24 pièces   24 piezas Cuberteria de mesa   24delig Tafelbestek   Servizio tavola 24 pos. 6 x Art-No. 004, 005, 006, 021 Canteen   Coffre   Caja   Cassette   Cassette 30276030 EURO 48,-	780,-	●	●
30-piece set   Service à Menu 30 pièces   30 piezas Cuberteria de mesa   30delig Tafelbestek   Servizio tavola 30 pos. 6 x Art-No. 004, 005, 006, 021, 027 Canteen   Coffre   Caja   Cassette   Cassette 30276030 EURO 48,-	948,-	●	●
10 Serving pieces   10 Pièces pour servir   10 Piezas de servir   10delig Diengarnituur   10 Posate da servire 2 x Art-No. 031, 1 x 025, 1 x 040/041, 2 x 039, 1 x 035, 1 x 052, 1 x 064 Canteen   Coffre   Caja   Cassette   Cassette 30276010 EURO 48,-	627,-	●	●
70-piece set   Service à Menu 70 pièces   70 piezas Cuberteria de mesa   70delig Tafelbestek   Servizio tavola 70 pos. 12 x Art-No. 004, 005, 006, 021, 027, 2 x 031, 1 x 025, 1 x 040/041, 2 x 039, 1 x 035, 1 x 052, 1 x 064	2.523,-	●	●
75-piece set   Service à Menu 75 pièces   75 piezas Cuberteria de mesa   75delig Tafelbestek   Servizio tavola 75 pos. 12 x Art-No. 004, 005, 006, 008, 009, 021, 1 x 039, 1 x 038, 1 x 036	2.772,-	●	●
128-piece set   Service à Menu 128 pièces   128 piezas Cuberteria de mesa   128delig Tafelbestek   Servizio tavola 128 pos. 12 x Art-No. 004, 005, 006, 007, 008, 009, 021, 027, 010, 011, 1 x 052, 1 x 065, 1 x 036, 1 x 035, 2 x 039 und 1 x 040/041	4.586,-	●	●

\* matt finished | mat | cepillado mate | mat | opaco refinito

Art. No.   Art. Nr.   Ref.   Art.-Nr.   Art. no.			
004 Menu spoon   Cuiller à menu   Cuchara mesa   Tafellepel   Cucchiaino tavola	31,-	●	●
005 Menu fork   Fourchette à menu   Tenedor mesa   Tafelvork   Forchetta tavola	31,-	●	●
006 Menu knife   Couteau à menu   Cuchillo mesa   Tafelmes   Coltello tavola	43,-	●	●
007 Dessert spoon   Cuiller à dessert   Cuchara postre/entremés   Dessertlepel   Cucchiaino frutta	31,-	●	●
008 Dessert fork   Fourchette à dessert   Tenedor postre/entremés   Dessertvork   Forchetta frutta	31,-	●	●
009 Dessert knife   Couteau à dessert   Cuchillo postre/entremés   Dessertmes   Coltello frutta	43,-	●	●
020 Coffee spoon, large   Cuiller à café, grande   Cuchara café, grande   Koffielepel, groot   Cucchiaino tè e colazione	28,-	●	●
021 Coffee spoon   Cuiller à café   Cuchara café   Koffielepel   Cucchiaino caffè-tè	25,-	●	●
022 Tea spoon III   Cuiller à thé   Cuchara té   Theelepelle III   Cucchiaino tè	25,-		
023 Mocha-/espresso spoon   Cuiller à moka   Cuchara moca   Mokka-/Espresso lepel   Cucchiaino moca/espresso	21,-	●	●
027 Cake fork, large   Fourchette à gâteaux, grande   Tenedor tarta   Taartvorkje   Forchetta dolci	28,-	●	●
010 Fish knife   Couteau à poisson   Cuchillo pescado   Vismes   Coltello pesce	35,-	●	●
011 Fish fork   Fourchette à poisson   Tenedor pescado   Visvork   Forchetta pesce	31,-	●	●
097 Gourmet spoon   Cuiller gourmet   Cuchara gourmet   Gourmetlepel   Cucchiaino salsa individuale	42,-	●	●
068 Fruit knife   Couteau à fruits   Cuchillo fruta   Fruitmes (Taartmesje)   Coltello dolci	43,-	●	●
084 Steak knife   Couteau à steak   Cuchillo steak   Steakmes   Coltello bistecca	59,-	●	●
025 Broth spoon   Cuiller à consommé   Cuchara taza   Bouillonlepel/Roomlepel   Cucchiaino brodo/panna	35,-	●	●
071/072 Butter/cheese knife   Couteau à beurre et à fromage   Cubierto de mantequilla y queso   B.- en Kaasmesje   Coltello burro/formaggio	62,-		
091/092 Butter and cheese knife, hollow handle   dito, lame inox   ídem, con hoja de acero   dito, met stalen lemmet   Coltello burro/formaggio	92,-	●	●
031 Meat fork, large   Fourchette à viande, grande   Tenedor carne, grande   Vleesdienvork, groot   Forchetta carne, grande	46,-	●	●
032 Meat fork, small   dito, petite   ídem, pequeño   Vleesdienvork, klein   Forchetta carne, piccola	42,-	●	●
050 Pastry server   Pelle à gâteaux   Pala bizcocho   Gebakscjep   Pala dolci	58,-	●	●
038 Vegetable fork   Fourchette à légumes   Tenedor verdura   Dienvork   Forchetta legumi	106,-	●	●
014 Children's spoon   Cuiller pour enfants   Cuchara infantil   Kinderlepel   Cucchiaino per bambini	28,-		
015 Children's fork   Fourchette pour enfants   Tenedor infantil   Kindervork   Forchetta per bambini	28,-		
016 Children's knife   Couteau pour enfants   Cuchillo infantil   Kindermes   Coltello per bambini	43,-		
040 Compote spoon, large   Cuiller à entremets, grande   Cuchara compota, grande   Puddingschep, groot   Cucchiaino serv. insalata, gr.	66,-	●	●
042 Compote spoon, small   dito, petite   ídem, pequeña   Puddingschep, klein   Cucchiaino serv. insalata, picc.	52,-		
025 Cream spoon   Cuiller à crème   Cuchara nata   Slagroomlepel   Cucchiaino brodo/panna	35,-	●	●
061 Cream spoon, bent   Cuiller à crème, cintrée   Cuchara nata, curvada   Slagroomlepel, gebogen   Cucchiaino panna, piegato	35,-		
040/041 Salad serving set, large   Service à salade, grande   Cubierto ensalada, grande   Saladecouvert, groot   Cucch. e forch. serv. ins., gr.	132,-	●	●
042/043 Salad serving set, small   dito, petite   ídem, pequeño   Saladecouvert, klein   Cucch. e forch. serv. ins., picc.	104,-		
035 Sauce ladle   Cuiller à sauce   Cuchara salsa   Sauslepel   Cucchiaino salsa	79,-	●	●
039 Serving Spoon   Cuiller à servir   Servicio vegetales   Dienlepel   Cucchiaino servire	91,-	●	●
036 Soup ladle   Louche   Cazo sopa   Soeplepel   Mestolo	127,-	●	●
052 Tart server   Pelle à tarte   Pala tarta   Taartschep   Pala torta	72,-	●	●
054 Tart knife   Couteau à tarte   Cuchillo tarta   Taartmes   Coltello torta	78,-	●	●
048/049 Carving knife and fork   Service à découper   Cubierto trinchar   Trancheercouvert   Coltello e forchetta trinciante	184,-	●	●
064 Sugar spoon   Cuiller à sucre   Cucharilla azúcar   Suikerlepel   Cucchiaino zucchero	35,-	●	●
065 Sugar tongs   Pince à sucre   Pinzas azúcar   Suikertang   Pinza zucchero	46,-	●	●



Silver care products / Cases | Entretien et entreposage d'argenterie  
 Cuidado y conservación de plata | Etuis / Bestektassen / Afdekdoeken  
 Manutenzione e custodia per le posate di argento

EURO



Cases | Coffrets | Estuches | Etuis | Astucci

4-piece case | Coffret pour 4 pièces | Estuche, 4 piezas  
 Etui, 4dlg. | Astuccio, posate tavola 4 pos.

31080001 19,–

19 x 26,5 x 4,5 cm

Suitable for | Utilisable pour | Para guardar  
 Geschikt voor | Composte da: 1x (04) (05) (06) (21)

24/30-piece box | Coffret pour 24 et 30 pièces  
 Caja, 24 piezas o 30 piezas | Kist, 24dlg. of 30dlg.  
 Cassetta, servizio tavola 24 o 30 pos.

30270030 55,–

41,5 x 34,0 x 7,0 cm

Suitable for | Utilisable pour | Para guardar  
 Geschikt voor | Composte da: 6x (04) (05) (06) (21) (27)

9-piece box | Coffret pour 9 pièces | Caja, 9 piezas  
 Kist, 9dlg. | Cassetta, servizio tavola 9 pos.

30270109 55,–

41,5 x 34,0 x 7,0 cm

Suitable for | Utilisable pour | Para guardar  
 Geschikt voor | Composte da: 2x (31), 1x (33) (38) (44) (25) (35) (52) (64)



Cloth pouches | Trousses

Bolsas | Bestektassen | Buste da posate

Suitable for | Utilisable pour | Para guardar | Geschikt voor | Composte da:

31708101 1x (4) / (5) 3,–

31708102 1x (6) 3,–

31708103 1x (20) / (27) 3,–

31708104 1 large serving item | 1 grande pièce à servir | 1 pieza de servir grande  
 1 groot Diendeel (bijv. Groentelepel) | Grosse posate oppure posto tavola 4,–

31708105 1x (36) / (47) 5,–

31708001 12x (4) 20,–

31708002 12x (5) / (6) 20,–

31708003 12x (20) / (27) 17,–

31708004 6 large serving items | 6 grandes pièces à servir | 6 piezas de servir grandes  
 6 grote Diendelen (bijv. Groentelepels) | Posate da servire oppure posto tavola 19,–

31708020 1x (4), (5), (6), (20), (27) 16,–

Covering cloth | Carrées de toile

Paños protectores | Afdekdoeken | Panno da coprire

31708014 36,0 x 28,5 cm 12,–

31708016 36,0 x 25,5 cm 12,–

31708017 40,0 x 30,5 cm 12,–

31708018 52,0 x 29,5 cm 13,–

31708019 51,5 x 38,5 cm 13,–



Silver care products | Des produits d'entretien d'argenterie

Serie de cuidado de plata | Zilveronderhoud serie

Linea di manutenzione

30408030 Silver polishing cloth | Chiffon spécial pour l'argenterie  
 Paño limpiaplata | Zilverpoetsdoek | Panno per lustrare 15,–

30408032 Silver polish | Produit de polissage d'argenterie  
 Detergente para plata | Zilver polish | Lucido per argento 250 ml 17,–

30408031 Silver foam | Mousse de polissage d'argenterie  
 Espuma para plata | Zilver schuim | Schiuma per argento 200 g 19,–

30408034 Polishing mitt | Gant pour nettoyer  
 Guante para limpiar | Putshandschoen | Guanto per lustrare 13,–

Canteens | Coffres | Cajas | Cassettes | Cassette



Mahogany  
Acajou  
Caoba  
Mahonie  
Acagiù

39 pcs.   pcs.   pzs.   dlq.   pz.	43,8 cm x 33,5 cm x 24,8 cm	Nr. 30271039	545,-
69 pcs.   pcs.   pzs.   dlq.   pz.	49,5 cm x 38,5 cm x 25,8 cm	Nr. 30271169	585,-
133 pcs.   pcs.   pzs.   dlq.   pz.	61,0 cm x 37,0 cm x 33,8 cm	Nr. 30271133	830,-
185 pcs.   pcs.   pzs.   dlq.   pz.	61,0 cm x 46,0 cm x 56,8 cm	Nr. 30271185	1.230,-
263 pcs.   pcs.   pzs.   dlq.   pz.	61,0 cm x 46,0 cm x 56,8 cm	Nr. 30271263	1.290,-



Red lacquered  
Laque Rouge  
Lacada en rojo  
Rood Gelakt  
Verniciato rosso

39 pcs.   pcs.   pzs.   dlq.   pz.	43,5 cm x 35,0 cm x 22,0 cm	Nr. 30272039	695,-
69 pcs.   pcs.   pzs.   dlq.   pz.	47,2 cm x 40,0 cm x 22,5 cm	Nr. 30272069	760,-
133 pcs.   pcs.   pzs.   dlq.   pz.	60,0 cm x 36,5 cm x 37,5 cm	Nr. 30272133	945,-



Pearwood\* (black lacquered)  
Poirier\* (cadres: laque noir)  
Peral\* (marcos lacados en negro)  
Perenhout\* (Omlijsting: Zwart gelakt)  
Pero\*, cornice verniciata in negro

39 pcs.   pcs.   pzs.   dlq.   pz.	45,8 cm x 31,5 cm x 23,5 cm	Nr. 30273039	580,-
69 pcs.   pcs.   pzs.   dlq.   pz.	51,5 cm x 37,2 cm x 23,7 cm	Nr. 30273069	720,-
133 pcs.   pcs.   pzs.   dlq.   pz.	62,5 cm x 36,3 cm x 35,4 cm	Nr. 30273133	930,-
185 pcs.   pcs.   pzs.   dlq.   pz.	62,5 cm x 45,3 cm x 59,0 cm	Nr. 30273185	1.260,-
263 pcs.   pcs.   pzs.   dlq.   pz.	62,5 cm x 45,3 cm x 59,0 cm	Nr. 30273263	1.320,-

All cutlery canteens can be individually configured to suit the cutlery that you have ordered.  
L'agencement de toutes les ménagères peut être personnalisé en fonction des couverts que vous avez achetés.  
Todos los estuches pueden personalizarse también acordes a las piezas de cubertería adquiridas  
Alle cassettes kunnen ook individueel in overeenstemming met het door u gekochte bestek ingedeeld worden.  
Tutte le cassette possono essere preparate anche individualmente secondo le posate da voi acquistate.



Martelé



Cocktailshaker with glass Ø 9,3 cm, H 16,8 cm\*  
Cocktailshaker avec verre  
Cóctelera con copa de cristal  
Cocktailshaker met glas  
Shakerati con bicchiere di vetro

\*without glass | \*sans verre | \*sin copa de cristal  
\*zonder glas | \*senza bicchiere di vetro

609,-  
06301507

Martelé



Longdrink and beer tumbler Ø 7,8 cm, H 12,0 cm  
Gobelet à longdrink et bière  
Copa cerveza/long drink | Longdrink/bier beker  
Tumbler long drink/birra

Vodkabeaker Ø 4,8 cm, H 4,5 cm  
Coupe à vodka | Vaso para vodka  
Wodkabeaker | Bicchiere per vodka

Gin, water and wine tumbler Ø 7,8 cm, H 8,9 cm  
Gobelet à Gin, eau et vin | Copa ginebra/vino/aqua  
Gin/water/wijnbeker | Bicchiere da gin/acqua/vino

Rum and distillate tumbler Ø 7,1 cm, H 6,3 cm  
Gobelet à rhum et destillat | Copa ron/destilado  
Rumbeker/destillaat | Bicchiere rum/distillato

298,-  
06301584

137,-  
06301581

284,-  
06301583

259,-  
06301582

Martelé



Whiskey tumbler | Gobelet à whiskey Ø 8,3 cm, H 8,0 cm  
Copa de whiskey | Whiskey beker  
Bicchiere da whiskey

309,-  
06301585

Martelé



Bottle-coaster Ø 14,5 cm  
Sous-bouteille  
Posabotella  
Flesonderzetter  
Sottobottiglia

Coaster Ø 11,5 cm  
Sous-verre  
Bandeja para vasos  
Serveerblad  
Vassoio per bicchieri

103,-  
06301521

88,-  
06301520

Bar Collection | Bar Collection | Colección del bar | Bar collectie | Collezione da bar

150  
massive  
silver  
plated  
EURO

90  
silver  
plated  
EURO

Belvedere



Bar spoon | Bar spoon | Cuchara bar  
Bar spoon | Cucchiaino da bar

– 278,–  
06801502

Nutcracker | Casse-noix | Cascanueces  
Notenkraker | Schiaccianoci

268,–  
06802203

Jigger | Jigger | Jigger Ø 5,0 cm, 7,7 cm  
Maatbeker | Misurino da bar

– 288,–  
06801510

Bottle-opener | Ouvre-bouteille  
Abridor | Flesopener | Apribottiglia

98,–  
06802206

Cocktailstrainer | Passoire à cocktail  
Colador para cóctel | Cocktailzeef  
Strainer da bar

142,–  
06802501

Cocktailstick | Broche à cocktail  
Brocheta de cóctel | Cocktailprikker  
Forchettina per cocktail

50,–  
51402005

Champagne tongs | Pince à Champagne  
Abridor champan | Champagneopener  
Apribottiglia Champagne

262,–  
06802313

Silver straw | Paille brillante | Pajita  
Rietje | Cannuccia

– 63,–  
50801090

Belvedere



Champagne flute Ø 5,4 cm, 19,4 cm  
Coupe de champagne  
Copa champana  
Champagnekelk  
Flûte Champagne

– 298,–  
06801598

Belvedere



Cocktail coupe Ø 11,5 cm, 12,8 cm  
Coupe à cocktail  
Copa de cóctel  
Cocktailglas  
Coppa cocktail

– 254,–  
06801597

Belvedere



Snackbar  
11,8 cm  
10,5 cm  
23,8 cm

– 595,–  
06801596



Belvedere



Cocktailshaker with glass  
Cocktailshaker avec verre  
Cóctelera con copa de cristal  
Cocktailshaker met glas  
Shakerati con bicchiere di vetro

Ø 9,3 cm  
↓ 16,8 cm\*

\*without glass | \*sans verre | \*sin copa de cristal  
\*zonder glas | \*senza vicchiere di vetro

Gin, water and wine tumbler Ø 7,8 cm, ↓ 8,9 cm 284,-  
06801583

Gobelet à Gin, eau et vin  
Copa ginebra/vino/aqua  
Gin/water/wijnbeker  
Bicchiere da gin/acqua/vino

Rum and distillate tumbler Ø 7,1 cm, ↓ 6,3 cm 259,-  
06801582

Gobelet à rhum et destillat  
Copa ron/destilado | Rumbeker/destillaat  
Bicchiere rum/distillato

Vodka beaker Ø 4,8 cm, ↓ 4,5 cm 192,-  
06801581

Coupe à vodka | Vaso para vodka  
Wodkabeker | Bicchiere per vodka

Belvedere



Longdrink and beer tumbler 311,-  
06801584

Gobelet à longdrink et bière  
Copa cerveza/long drink  
Longdrink/bier beker  
Bicchiere da long drink / birra

Ø 7,8 cm  
↓ 12,0 cm

Belvedere





Whiskey tumbler | Gobelet à whiskey 338,-  
06801585

Copa de whiskey | Whiskey beker  
Bicchiere da whiskey

Ø 8,3 cm  
↓ 8,0 cm

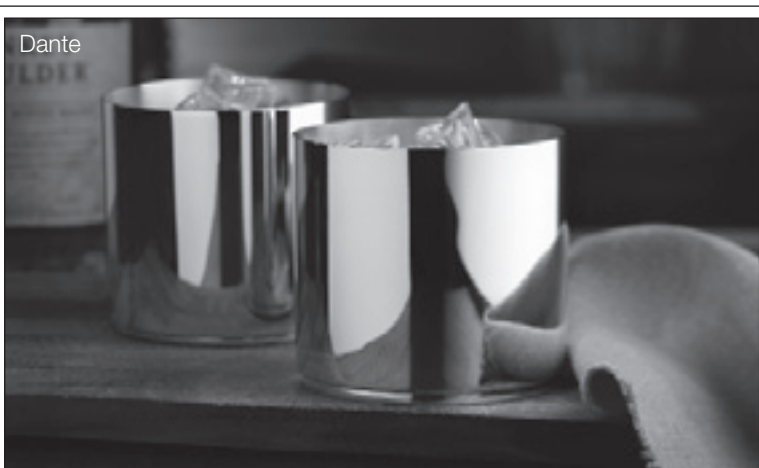

<p>Dante</p> 	<p>Cocktailshaker with glass Cocktailshaker avec verre Cóctelera con copa de cristal Cocktailshaker met glas Shakerati con bicchiere di vetro</p> <p>Ø 9,3 cm 16,8 cm*</p> <p>*without glass   *sans verre   *sin copa de cristal *zonder glas   *senza bicchiere di vetro</p>	<p>473,- 06201507</p>	<p>-</p>
<p>Dante</p> 	<p>Longdrink and beer tumbler Gobelet à longdrink et bière Copa cerveza/long drink Longdrink/bier beker Bicchiere da long drink / birra</p> <p>Ø 7,8 cm 12,0 cm</p>	<p>297,- 06201584</p>	<p>433,- 06231584</p>
<p>Dante</p> 	<p>Vodkabeaker Coupe à vodka   Vaso para vodka Wodkabeker   Bicchiere per vodka</p> <p>Rum and distillate tumbler Gobelet à rhum et distillat Copa ron/destilado   Rumbeker/destillaat Bicchiere rum/distillato</p> <p>Gin, water and wine tumbler Gobelet à Gin, eau et vin Copa ginebra/vino/aqua Gin/water/wijnbeker Bicchiere da gin/acqua/vino</p> <p>Coaster   Sous-verre   Bandeja para vasos Sous-verre   Serverblad Sottobicchiere</p> <p>Bottle-coaster   Sous-bouteille Posabotella   Flesonderzetter Sottobottiglia</p> <p>Ø 4,8 cm, 4,5 cm Ø 7,1 cm, 6,3 cm Ø 7,8 cm, 8,9 cm Ø 11,5 cm Ø 14,5 cm</p>	<p>175,- 06201581</p> <p>216,- 06201582</p> <p>251,- 06201583</p> <p>82,- 06201520</p> <p>95,- 06201521</p>	<p>225,- 06231581</p> <p>323,- 06231582</p> <p>360,- 06231583</p> <p>-</p> <p>-</p>
<p>Dante</p> 	<p>Whiskey tumbler   Gobelet à whiskey Copa de whiskey   Whiskey beker Bicchiere da whiskey</p> <p>Ø 8,3 cm, 8,0 cm</p>	<p>260,- 06201585</p>	<p>369,- 06231585</p>



Bar trolley | Chariot de bar | Carro de bar | Bar trolley | Carrello bar

5.700,-  
30108232

Material | Matériau | Material | materiaal | Materiale

Wheels and body: Thermo ash (FSC certified; oiled)  
 Roues et carrosserie: Frêne thermo (certifié FSC; huilé)  
 Ruedas y carrocería: Termo ceniza (certificado FSC; aceitado)  
 Wielen en carrosserie: Thermo essen (FSC gecertificeerd; geolied)  
 Ruote e corpo: Frassino termico (certificato FSC; oliato)

Railing: Stainless steel covered with nappa leather  
 Balustrade: Acier inoxydable recouvert de cuir nappa  
 Barandilla: Acero inoxidable recubierto de napa  
 Trailiewerk: Roestvrij staal gecoat met nappaleer  
 Ringhiera: Acciaio inossidabile ricoperto di nappa

Weight | Poids | Peso approx. 29 kg | environ 29 kg | aprox. 29 kg  
 gewicht | Peso ca. 29 kg | circa 29 kg

Trolley dimensions: ↗ 920 x ↔ 576 x ↓ 885 mm  
 Dimensions du chariot:  
 Dimensiones del carro:  
 Afmetingen trolley:  
 Dimensioni del carrello:

Individualisation option: Placement of your logo on both sides of the trolley  
 Option d'individualisation: Placement de votre logo sur les deux côtés du chariot  
 Opción de individualización: Colocación de su logotipo en ambos lados del carro  
 Aanpassingsoptie: Uw logo aan beide zijden van de auto plaatsen  
 Opzione di personalizzazione: Posizionamento del vostro logo su entrambi i lati del carrello

Locking wheel/brake: available  
 Roue/frein de blocage: disponible  
 Bloqueo de la rueda/freno: disponible  
 Vergrendeling wiel/rem: beschikbaar  
 Bloccaggio ruota/freno: disponibile



Bar trolley | Chariot de bar | Carro de bar | Bar trolley | Carrello bar  
 Bar trunk | Malle armoire de bar | Maleta bar | Koffer bar | Valigia da bar

EURO\*



Bar trolley | Chariot de bar | Carro de bar | Bar trolley | Carrello bar

6.200,-  
30108234

Material | Matériau | Material | materiaal | Materiale

Wheels and body: Oak (oiled)  
 Roues et carrosserie: Chêne (huilé)  
 Ruedas y carrocería: Roble (aceitado)  
 Wielen en carrosserie: Eik (geolied)  
 Ruote e corpo: Rovere (oliato)

Railing: Stainless steel covered with nappa leather  
 Balustrade: Acier inoxydable recouvert de cuir nappa  
 Barandilla: Acero inoxidable recubierto de napa  
 Trailiewerk: Roestvrij staal gecoat met nappaleer  
 Ringhiera: Acciaio inossidabile ricoperto di nappa

Weight | Poids | Peso approx. 29 kg | environ 29 kg | aprox. 29 kg  
 gewicht | Peso ca. 29 kg | circa 29 kg

Trolley dimensions: 920 x 576 x 885 mm

Dimensions du chariot:

Dimensiones del carro:

Afmetingen trolley:

Dimensioni del carrello:

Individualisation option: Placement of your logo on both sides of the trolley  
 Option d'individualisation: Placement de votre logo sur les deux côtés du chariot  
 Opción de individualización: Colocación de su logotipo en ambos lados del carro  
 Aanpassingsoptie: Uw logo aan beide zijden van de auto plaatsen  
 Opzione di personalizzazione: Posizionamento del vostro logo su entrambi i lati del carrello

Locking wheel/brake: available  
 Roue/frein de blocage: disponible  
 Bloqueo de la rueda/freno: disponible  
 Vergrendeling wiel/rem: beschikbaar  
 Bloccaggio ruota/freno: disponibile



Bar trunk  
 Malle armoire de bar  
 Maleta bar  
 Koffer bar  
 Valigia da bar

3.900,-  
30108222

150 cm  
 62 cm  
 59 cm

Only available in combination with bar products.  
 Disponible uniquement en combinaison avec les produits de bar.  
 Solamente disponible en combinación con productos del bar.  
 Alleen beschikbaar in combinatie met barproducten.  
 Disponibile solo in combinazione con prodotti da bar.

## The Box

925  
Sterling  
Silver  
EURO

150  
massive  
silver  
plated  
EURO

Belvedere



With shiny blades  
Avec des lames brillantes  
Con hojas brillantes  
Met glanzende messen  
Con lame lucide

24-piece set | Ensemble de 24 pièces | Juego de 24 piezas  
24-delige set | Set da 24 pezzi

6.404,-

2.708,-

Content | Contenu | Contenido | inhoud | Contenuto  
6x Menu spoon | 6x Cuiller à menu | 6x Cuchara mesa | 6x Tafellepel | 6x Cucchiaino tavola  
6x Menu fork | 6x Fourchette à menu | 6x Tenedor mesa | 6x Tafelvork | 6x Forchetta tavola  
6x Menu knife | 6x Couteau à menu | 6x Cuchillo mesa | 6x Tafelmes | 6x Coltello tavola  
6x Coffee spoon | 6x Cuiller à café | 6x Cuchara café | 6x Koffielepel | 6x Cucchiaino caffè-tè

Available in the collections | Disponible dans les collections  
Disponible en las colecciones | Verkrijgbaar in de collecties | Disponibile nelle collezioni:  
Martelé, Riva, Belvedere, Alta, Arcade, Art Deco, Alt-Chippendale, Alt-Spaten, Avenue,  
Dante, Eclipse, Ostfriesen, Rosenmuster, Spaten, Viva

With Frozen Black knife blades  
Avec des lames de couteau Frozen Black  
Con hojas de cuchillo Frozen Black  
Met Frozen Black mesbladen  
Con lame di coltello Frozen Black

24-piece set | Ensemble de 24 pièces | Juego de 24 piezas  
24-delige set | Set da 24 pezzi

6.644,-

2.948,-

Content | Contenu | Contenido | inhoud | Contenuto  
6x Menu spoon | 6x Cuiller à menu | 6x Cuchara mesa | 6x Tafellepel | 6x Cucchiaino tavola  
6x Menu fork | 6x Fourchette à menu | 6x Tenedor mesa | 6x Tafelvork | 6x Forchetta tavola  
6x Menu knife | 6x Couteau à menu | 6x Cuchillo mesa | 6x Tafelmes | 6x Coltello tavola  
6x Coffee spoon | 6x Cuiller à café | 6x Cuchara café | 6x Koffielepel | 6x Cucchiaino caffè-tè

Available in the collections | Disponible dans les collections  
Disponible en las colecciones | Verkrijgbaar in de collecties | Disponibile nelle collezioni:  
Martelé, Riva, Belvedere

Available only in combination with a silver or silverplated 24-piece set from  
one of the collections listed above.

Disponible uniquement en combinaison avec un set de 24 pièces en argent  
ou métal argenté d'une des collections ci-dessus.

Disponible sólo en combinación con un juego de 24 piezas en plata o plateado  
de una de las colecciones mencionadas anteriormente.

Alleen verkrijgbaar in combinatie met een zilver of verzilverde 24-delige set  
uit een van bovenstaande collecties.

Disponibile solo in combinazione con un set di 24 pezzi in argento o argentato  
di una delle collezioni sopra elencate.

∅ 30,0 cm, ⇄ 20,4 cm, ↗ 20,4 cm

Prices include the box worth 380,- Euro.

Prix incluant la boîte d'une valeur de 380,- euros.

Los precios incluyen The Box, valorada en 380,- euros.

De prijzen zijn inclusief The Box ter waarde van 380,- Euro.

I prezzi includono The Box del valore di 380,- Euro.

Martelé



Champagner Box



### CHAMPAGNE BOX

Including four silver-plated flutes from the collections:  
Avec quatre flutes argentés des collections :  
Con cuatro copas champana plateadas de las colecciones:  
Met vier verzilverde champagnekelk uit de collecties:  
Con quattro flute champagne argentati delle collezioni:

Martelé 1.516,-

Belvedere 1.516,-

Dante 1.456,-

Prices include the box worth 380,- Euro.

Prix incluant la boîte d'une valeur de 380,- euros.

Los precios incluyen The Box, valorada en 380,- euros.

De prijzen zijn inclusief The Box ter waarde van 380,- Euro.

I prezzi includono The Box del valore di 380,- Euro.

Barbecue collection | Barbecue collection | Colección Barbacoa  
Barbecue collectie | Collezione barbecue

925

Sterling  
Silver  
EURO

150

massive  
silver  
plated  
EURO

Alt-Spaten



Carving fork | Fourchette à découper  
Tenedor de trinchar | Trancheervork  
Forchetta trinciante (Frozen Black) ↔ 22,5 cm

439,-  
01903149

299,-  
01902149

Carving knife | Couteau à découper  
Cuchillo de trinchar | Trancheermes  
Coltello trinciante (Frozen Black) ↔ 25,0 cm

439,-  
01903148

299,-  
01902148

Steak fork/Menu fork  
Fourchette à steak/Fourchette à menu  
Tenedor steak/Tenedor mesa  
Steakvork/Tafelvork  
Forchetta bistecca/ Forchetta tavola ↔ 20,4 cm

298,-  
01903005

95,-  
01902005

Steak knife | Couteau à steak  
Cuchillo steak | Steakmes  
Coltello bistecca (Frozen Black) ↔ 22,2 cm

299,-  
01903184

162,-  
01902184

Martelé



Carving fork | Fourchette à découper  
Tenedor de trinchar | Trancheervork  
Forchetta trinciante (Frozen Black) ↔ 25,0 cm

439,-  
06303149

291,-  
06302149

Carving knife | Couteau à découper  
Cuchillo de trinchar | Trancheermes  
Coltello trinciante (Frozen Black) ↔ 29,3 cm

439,-  
06303148

291,-  
06302148

Steak fork/Menu fork  
Fourchette à steak/Fourchette à menu  
Tenedor steak/Tenedor mesa  
Steakvork/Tafelvork  
Forchetta bistecca/ Forchetta tavola ↔ 20,0 cm

298,-  
06303005

95,-  
06302005

Steak knife | Couteau à steak  
Cuchillo steak | Steakmes  
Coltello bistecca (Frozen Black) ↔ 22,5 cm

299,-  
06303184

162,-  
06302184

Riva



Carving fork | Fourchette à découper  
Tenedor de trinchar | Trancheervork  
Forchetta trinciante (Frozen Black) ↔ 28,0 cm

439,-  
06403149

291,-  
06402149

Carving knife | Couteau à découper  
Cuchillo de trinchar | Trancheermes  
Coltello trinciante (Frozen Black) ↔ 31,8 cm

439,-  
06403148

291,-  
06402148

Steak fork/Menu fork  
Fourchette à steak/Fourchette à menu  
Tenedor steak/Tenedor mesa  
Steakvork/Tafelvork  
Forchetta bistecca/ Forchetta tavola ↔ 21,2 cm

298,-  
06403005

95,-  
06402005

Steak knife | Couteau à steak  
Cuchillo steak | Steakmes  
Coltello bistecca (Frozen Black) ↔ 22,3 cm

299,-  
06403184

162,-  
06402184



Wooden bowls | Jattes en bois | Bol de madera  
Houten schaal | Coppa di legno **12**

Bowl (teak) | Jatte (teck) | Bol (teca)  
Schaal (teak) | Coppa (teak)

↔ ca. 29,0 cm  
↔ ca. 6,9 cm

73,-  
51402040

Bowl (acacia) | Jatte (acacia) | Bol (acacia)  
Schaal (acacia) | Coppa (acacia)

↔ 29,0 cm  
↔ ca. 6,9 cm

73,-  
51402041

Bowl (teak), large | Jatte (teck), grande  
Bol (teca), grande | Schaal (teak), groot  
Coppa (teak), grande

↔ ca. 38,0 cm  
↔ ca. 8,8 cm

83,-  
51402042

Bowl (acacia), large | Jatte (acacia), grande  
Bol (acacia), grande | Schaal (acacia), groot  
Coppa (acacia), grande

↔ 38,0 cm  
↔ ca. 8,8 cm

83,-  
51402043

Table accessories   Accessoires de table   Servicios de mesa   Tafelaccessoires   Accessori da tavola Gift items   Cadeaux   Artículos-regalo   Geschenken   Articoli da regalo		👑 925 Sterling Silver EURO	90 silver plated EURO
		Champagne flute Coupe de champagne Copa champana Champagnekelk Flûte Champagne	Ø 5 cm, ↓ 25 cm 1.450,- 05003598 (275 g) 284,- 05001598
		Champagne cooler Seau à champagne Cubo para champaña Champagne koeler Secchiello per champagne  Ice bucket Seau à glace Cubo de hielo Ijsemmer Secchio da ghiaccio  Ice tongs   Pince a glace   Pinza de hielo Ijstang   Pinza da ghiaccio  Ice bucket lid Couvercle pour seau à glace Tapadera para cubo de hielo Deksel voor ijsemmer coperchio per secchio da ghiaccio	Ø 19,7 cm, ↓ 21,5 cm — 1.407,- 50801025  Ø 13,0 cm, ↓ 13,5 cm — 578,- 50801125  217,- 05003110 120,- 05002110 👤 150  — 315,- 50801126
		Champagne cooler Seau à champagne Cubo para champaña Champagne koeler Secchiello per champagne  Ice bucket Seau à glace Cubo de hielo Ijsemmer Secchio da ghiaccio  Ice bucket lid Couvercle pour seau à glace Tapadera para cubo de hielo Deksel voor ijsemmer coperchio per secchio da ghiaccio	Ø 19,7 cm, ↓ 21,5 cm — 2.090,- 06301587  Ø 13,0 cm, ↓ 13,5 cm — 922,- 06301588  — 425,- 06301589
		Champagne cooler with handles Seau à champagne avec poignées Cubo para champaña con asas Champagnekoeler met grepen Secchiello per champagne con manici  Corkscrew Tire-bouchon Sacacorchos Kurketrekker Cavatappi	Ø 20 cm, ↓ 20 cm 7.330,- 50803012 (1.500 g) 2.814,- 50801012  628,- 51403022



Table accessories | Accessoires de table | Servicios de mesa | Tafelaccessoires | Accessori da tavola  
 Gift items | Cadeaux | Artículos-regalo | Geschenken | Articoli da regalo

925  
 Sterling  
 Silver  
 EURO

90  
 silver  
 plated  
 EURO



Hip flask  
 Bouteille pour poche revoiver  
 Botella de bolsillo  
 Zakflacon  
 Fiaschetta

8,7 cm

1.230,-  
 51403024

-



Vodkabeaker  
 (with picture of one's choice)  
 Coupe à vodka  
 (avec motif souhaité)  
 Vaso para vodka  
 (con motivo usted desea)  
 Wodkabeaker  
 (motief naar wens)  
 Bicchiere per vodka  
 (con disegno à richiesta)

Ø 5,2 cm, 5,4 cm

388,-  
 50803017  
 (64 g)

189,-  
 50801017



Love Spoons  
 Love Spoon A  
 Love Spoon B

284,-  
 51403010

-

284,-  
 51403011

-



Taste-Vin

Ø 8 cm

420,-  
 51403016

-

Table accessories | Accessoires de table | Servicios de mesa | Tafelaccessoires | Accessori da tavola  
 Gift items | Cadeaux | Artículos-regalo | Geschenken | Articoli da regalo

925  
 Sterling  
 Silver  
 EURO

150  
 massive  
 silver  
 plated  
 EURO



Longdrink spoon | Cuiller à longdrink  
 Cuchara cocktail | Longdrink lepel  
 Cucchiaino cocktail

Dante	06203066	06202066	236,-	103,-
Glücksburger Faden	04203066	04202066	213,-	108,-
Arcade	05603066	05602066	213,-	108,-
Arcade Goldband	05633066	05632066	293,-	188,-
Navette	04803066	04802066	213,-	108,-
Martelé (p. 22)	-	06302066	-	110,-
Sphinx**	06903066	06902066	283,-	123,-



Bottle-opener | Ouvre-bouteille  
 Abridor | Flesopener | Apribottiglia

Französisch-Perl	04603206	04602206	135,-	103,-
Französisch-Perl*	04603106	04602106	297,-	136,-
Navette	04803206	04802206	135,-	103,-
Navette*	04803106	04802106	297,-	136,-
Arcade	05603206	05602206	135,-	103,-
Arcade*	05603106	05602106	297,-	136,-
Avenue	04403106	04402106	135,-	103,-
Martelé (p. 22)	-	06302206	-	98,-
Dante**	06203206	06202206	135,-	98,-



Letter-opener | Coupe-papier  
 Abre-cartas | Briefopener | Tagliacarte

Navette	04803201	04802201	197,-	148,-
Navette*	04803101	04802101	220,-	168,-
Französisch-Perl	04603201	04602201	197,-	148,-
Französisch-Perl*	04603101	04602101	220,-	168,-
Arcade	05603201	05602201	197,-	148,-
Arcade*	05603101	05602101	220,-	168,-
Avenue	04403101	04402101	197,-	148,-
Riva	06403101	-	435,-	-
Dante**	06203201	06202201	197,-	148,-



Magnifying glass | Loupe  
 Lupa | Leesloop | Lente d'ingrandimento

Französisch-Perl	04603202	04602202	220,-	164,-
Französisch-Perl*	04603102	04602102	236,-	178,-
Navette	04803202	04802202	220,-	164,-
Navette*	04803102	04802102	236,-	178,-
Arcade	05603202	05602202	220,-	164,-
Arcade*	05603102	05602102	236,-	178,-
Avenue	04403102	04402102	220,-	164,-
Dante**	06203202	06202202	220,-	164,-



Nutcracker | Casse-noix  
 Cascanueces | Notenkraker | Schiaccianoci

Französisch-Perl	04603203	04602203	377,-	281,-
Französisch-Perl*	04603103	04602103	408,-	308,-
Navette	04803203	04802203	377,-	281,-
Navette*	04803103	04802103	408,-	312,-
Arcade	05603203	05602203	377,-	281,-
Arcade*	05603103	05602103	408,-	312,-
Avenue	04403103	04402103	377,-	281,-
Martelé (p. 22)	-	06302203	-	268,-
Dante**	06203203	06202203	377,-	268,-

Table accessories | Accessoires de table | Servicios de mesa | Tafelaccessoires | Accessori da tavola  
 Gift items | Cadeaux | Artículos-regalo | Geschenken | Articoli da regalo

925  
 Sterling  
 Silver  
 EURO

90  
 silver  
 plated  
 EURO



Picture frame | Cadre  
 Marco | Fotolijst | Cornice

9 x 13 cm                      22 x 17 cm

1.030,-  
 51003001  
 (150 g)

320,-  
 51001001

13 x 18 cm                      22 x 17 cm

820,-  
 51003004  
 (110 g)

300,-  
 51001004



Picture frame, hatched  
 Cadre, haché  
 Marco, empollado  
 Fotolijst, met arcering  
 Cornice, con tratteggio

9 x 13 cm                      22 x 17 cm

1.080,-  
 51003002  
 (150 g)

380,-  
 51001002

13 x 18 cm                      22 x 17 cm

850,-  
 51003003  
 (110 g)

340,-  
 51001003



Appetizer spoon  
 Porte doucers  
 Cuchara "Appetizer"  
 Appetizerlepel  
 Cucchiaio "Appetizer"

10 cm x 4 cm

230,-  
 51403015

81,-  
 51402015

Table accessories | Accessoires de table | Servicios de mesa | Tafelaccessoires | Accessori da tavola  
 Gift items | Cadeaux | Artículos-regalo | Geschenken | Articoli da regalo

925  
 Sterling  
 Silver  
 EURO

150  
 massive  
 silver  
 plated  
 EURO



Chopsticks | Baguettes  
 Palillos para comer | Eetstokjes | Bastoncini

japanese (short + pointed)	chinese (long + blunt)		
japonais (court + pointu)	chinois (long + contondant)		
japonés (corto + agudo)	chino (largo + romo)		
japans (cort en spits)	chinees (lang en stomp)		
giapponese (corto + punta)	chinese (lungo + smussato)		

Hokkaido (2x 50303013)	Taishan (2x 50303023)	180,-	-
Honshu (2x 50303011)*	Huashan (2x 50303021)*	160,-	-
Kyushu (2x 50303014)	Songshan (2x 50303024)	190,-	-
Shikoku (2x 50303012)	Hengshan (2x 50303022)	115,-	-
Osumi (2x 50303010)	Huangshan (2x 50303020)	105,-	-

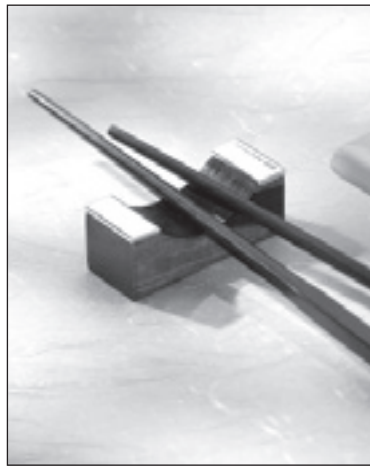

Chopstick rest  
 Porte-baguettes  
 Soporte de palillos para comer  
 Eetstokjes-Houder  
 Supporto per bastoncini

large   grand grande   groot   grande	138,- 50303029	-
small   petit pequeño   klein   piccolo	114,- 50303019	-



EDO

Gourmet fork Fourchette gourmet   Forchetta gourmet Gourmetvork   Tenedor gourmet	297,- 05403005	110,- 05402005
Gourmet knife Couteau gourmet   Cucchillo gourmet Gourmetmes   Coltello gourmet	262,- 05403006	153,- 05402006
Gourmet spoon Cuiller gourmet   Cuchara gourmet Gourmetlepel   Cucchiaino gourmet	297,- 05403004	110,- 05402004
Dessert spoon Cuiller à dessert   Cuchara postre Dessertlepel   Cucchiaino da dessert	236,- 05403007	92,- 05402007



Knife rest  
 Porte-couteau  
 Porta-cuchillos  
 Messenlegger  
 Supporto per coltello

Neutral	170,- 20003104	99,- 20002104
Alta	142,- 05003104	52,- 05002104

Table accessories   Accessoires de table   Servicios de mesa   Tafelaccessoires   Accessori da tavola Gift items   Cadeaux   Artículos-regalo   Geschenken   Articoli da regalo			 925 Sterling Silver EURO	90 silver plated EURO
<p>Alta</p> 	<p>Coffee pot Cafetière Cafetera Koffiekan Caffettiera</p> <p>1,3 l, Ø 11 cm, <math>\downarrow</math> 17 cm</p>	<p>5.770,- 05003501 (770 g)</p>	<p>2.740,- 05001501</p>	
<p>Alta</p> 	<p>Tea pot Théière Tetera Theepot Teiera</p> <p>1,3 l, Ø 14 cm, <math>\downarrow</math> 12 cm</p>	<p>5.770,- 05003502 (660 g)</p>	<p>2.740,- 05001502</p>	
<p>Alta</p> 	<p>Creamer Crémier Jarrita crema Melkkannetje Bricchetto p.l.panna</p> <p>Ø 5,8 cm, <math>\downarrow</math> 6,1 cm</p> <p>Sugar bowl Sucrier Azucarera Suikerpot Zuccheriera</p> <p>Ø 8,1 cm, <math>\downarrow</math> 4,2 cm</p> <p>Tray Plateau Bandeja Blad voor Roomstel Vassoio</p> <p>22 x 14 cm</p>	<p>1.360,- 05003503 (140 g)</p> <p>1.550,- 05003504 (230 g)</p> <p>1.780,- 05003523 (330 g)</p>	<p>864,- 05001503</p> <p>744,- 05001504</p> <p>620,- 05001523</p>	
<p>Alta</p> 	<p>Coffee and tea set, 4-pieces Service à café et à thé, 4 pcs. Juego de tazas de té y café, 4 piezas 4dlg. Koffie- en Theeservies Servizio da tè e caffè, 4 pezzi large   grand   grande   groot   grande</p> <p>Tray Plateau Bandeja Serveerblad Vassoio</p> <p>Ø 36 cm</p>	<p>14.450,- (1,800 g)</p> <p>5.300,- 05003526 (1.075 g)</p>	<p>7.088,-</p> <p>1.160,- 05001526</p>	

Table accessories   Accessoires de table   Servicios de mesa   Tafelaccessoires   Accessori da tavola Gift items   Cadeaux   Artículos-regalo   Geschenken   Articoli da regalo		925 Sterling Silver EURO	90 silver plated EURO
Alta		Mocha pot Cafetière à moka Cafetera Mokkakan Caffettiera 0,75 l, Ø 9,6 cm, 12 cm	4.310,- 05003505 (410 g) 2.450,- 05001505
Alta		Tea pot Théière Tetera Theepot Teiera Stand for tea pot Dessous de théière Platillo para tetera Onderzetter Sottocaffettiera 0,75 l, Ø 11,7 cm, 7,9 cm Ø 11,7 cm	4.310,- 05003506 (465 g) 940,- 05003530 - 2.450,- 05001506
Alta		Tray for mocha set Plateau à moka Bandeja para servicio Blad voor Mokkaservies Vassoio per servizio moca Ø 32 cm	3.300,- 05003525 (790 g) 990,- 05001525
Alta		Mocha and Tea set, 4-pieces Service à moka et à thé, 4 pcs. Juego de tazas de té y moca, 4 piezas 4dlg. Mokka- en Theeservies Servizio da tè e moca, 4 pezzi Tray Plateau Bandeja Serveerblad Vassoio Ø 36 cm	11.530,- (1.245 g) 6.508,- 5.300,- 05003526 (1.075 g) 1.160,- 05001526

Table accessories   Accessoires de table   Servicios de mesa   Tafelaccessoires   Accessori da tavola Gift items   Cadeaux   Artículos-regalo   Geschenken   Articoli da regalo		925 Sterling Silver EURO	90 silver plated EURO
<p>Alta</p> 	<p>Warmer, 1 flame                      Ø 15,5 cm, 6,5 cm Réchaud à 1 feu Calienta - platos, 1 llama Réchaud, 1-vlammig Scaldavivande a 1 fiamma</p>	<p>3.330,- 05003567 (400 g)</p>	<p>1.770,- 05001567</p>
<p>Alta</p> 	<p>Warmer, 2 flames                      16 x 25 cm, 6,5 cm Réchaud à 2 feus Calienta - platos, 2 llama Réchaud, 2-vlammig Scaldavivande a 2 fiamme</p>	<p>7.050,- 05003568 (850 g)</p>	<p>4.000,- 05001568</p>
	<p>Nut tree coaster with silver setting Coaster en noyer avec bordure en argent Posavasos de nogal con engaste plateado Notenhouten onderzetter met zilveren montuur Sottopiatto di legno di noce con bordo argentato</p> <p>Ø            16,5 cm H            3,5 cm</p>	<p>620,- 50803120</p>	<p>400,- 50801120</p>
	<p>Revolving tea strainer Passoire à thé rotative Colador de té giratorio Theezeef met zwenkend lekbakje Settacio da tè girevole</p> <p>H            ca. 4,5 cm Ø            6,5 cm H-H        ca. 16,0 cm</p> <p>Tea strainer with Corian handle &amp; drip tray Passoire à thé - manche en Corian &amp; l'égouttoir Colador de té - mango Corian &amp; bandeja de goteo Theezeef met Corian greep en lekbakje Settaccio da tè con manico Corian &amp; sottovaso</p> <p>H            3,5 cm Ø            ca. 7,2 cm H-H        ca. 13,0 cm</p>	<p>990,- 50803115</p> <p>990,- 50803116</p>	<p>580,- 50801115</p> <p>630,- 50801116</p>

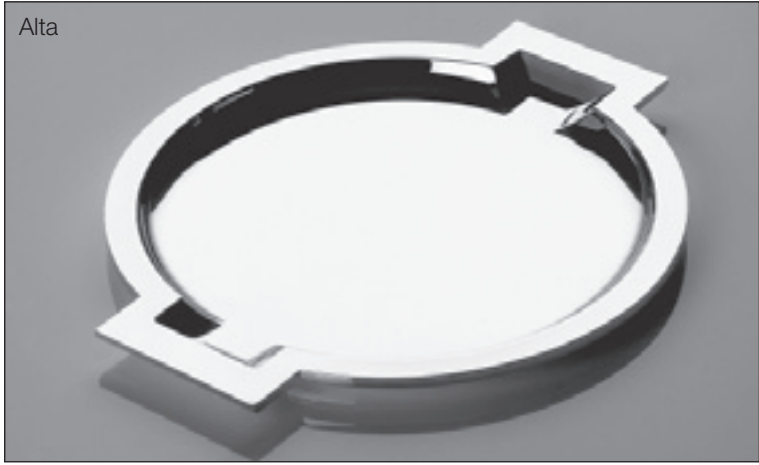
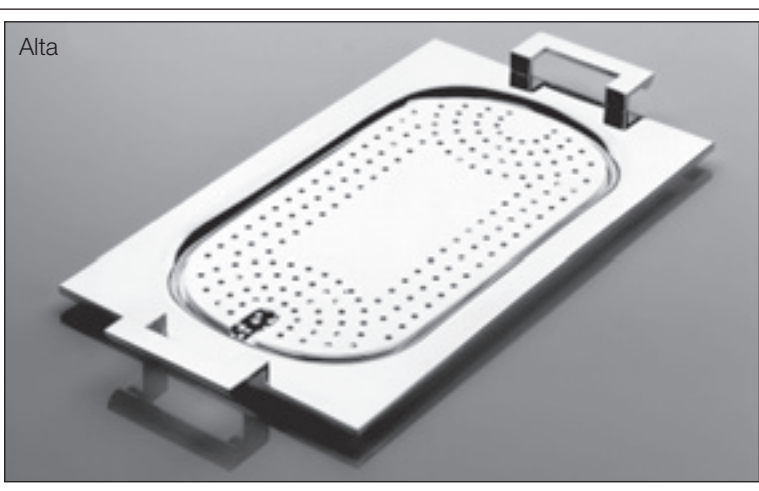

Table accessories   Accessoires de table   Servicios de mesa   Tafelaccessoires   Accessori da tavola Gift items   Cadeaux   Artículos-regalo   Geschenken   Articoli da regalo		925 Sterling Silver EURO	90 silver plated EURO
<p>Alta</p> 	<p>Vegetable platter Plat à servir Plato verdura Serveerschaal Piatto per verdure</p> <p>Ø 32 cm</p> <p>Ø 24 cm</p>	<p>5.870,- 05003528 (1.010 g)</p> <p>4.070,- 05003527 (620 g)</p>	<p>2.400,- 05001528</p> <p>1.910,- 05001527</p>
<p>Alta</p> 	<p>Tray Plateau) Bandeja Serveerblad Vassoio</p> <p>57 x 33 cm</p> <p>Fish/asparagus insert Grille à poissons/asperges Grill pescado/espárragos Vis-, Aspergeinlegrooster Inserto per pesce o asparagi</p> <p>47,5 x 24,5 cm</p> <p>Wooden board (beech) Planche en bois (hêtre) Tabla de madera (haya) Houten Snijplank (Beuken) Tavola di legno (faggio)</p> <p>284,- 05001566 47 x 26 cm</p>	<p>16.800,- 05003529 (3.130 g)</p> <p>7.070,- 05003565 (1.070 g)</p> <p>–</p>	<p>7.220,- 05001529</p> <p>4.000,- 05001565</p> <p>–</p>
<p>Alta</p> 	<p>Large bowl Grande jatte Fuente grande Serveerschaal Coppa grande</p> <p>38,5 x 50,5 cm, 13,5 cm</p>	<p>12.860,- 05003545 (2.020 g)</p>	<p>6.280,- 05001545</p>
<p>Alta</p> 	<p>Rectangular bowl Jatte, rectangulair Bol, rectangular Schaal, rechthoekig Coppa rettangolare</p> <p>17 x 14 cm 1,85 cm</p>	<p>1.750,- 05003546 (335 g)</p>	<p>–</p>



Table accessories   Accessoires de table   Servicios de mesa   Tafelaccessoires   Accessori da tavola Gift items   Cadeaux   Artículos-regalo   Geschenken   Articoli da regalo			 925 Sterling Silver EURO	90 silver plated EURO
Alta 	Tumbler Gobelet Vaso Beker Bicchiere	Ø 6,8 cm, $\updownarrow$ 6,5 cm	536,- 05003551 (130 g)	189,- 05001551
	Tumbler Gobelet Vaso Beker Bicchiere	Ø 6,4 cm, $\updownarrow$ 5,5 cm	620,- 05003564 (120 g)	-
	Tumbler, inside gold Gobelet, à l'intérieur doré Vaso con interior dorado Beker, binnen verguld Bicchiere con doratura interna	Ø 6,8 cm, $\updownarrow$ 6,5 cm	690,- 05003550 (130 g)	378,- 05001550
Alta 	Small bowl Jatte Bol pequeño Schaaltje Coppetta	Ø 16 cm	1.170,- 05003540 (285 g)	450,- 05001540
	Small plate Petite assiette Plata niños Klein Bordje Piattino	Ø 19 cm	1.270,- 05003522 (250 g)	396,- 05001522
	Child's cup Gobelet pour enfants Taza niños Kinderbeker Bicchiere per bambini	Ø 6,8 cm, $\updownarrow$ 6,5 cm	680,- 05003552 (125 g)	284,- 05001552
Alta 	Candlestick, with candle Chandelier, avec bougie Candelabro, con candela Kandelaar, met kaars Candeliere con candela	$\updownarrow$ 5 cm	1.080,- 05003510 (150 g)	540,- 05001510
		$\updownarrow$ 12 cm	1.270,- 05003511 (180 g)	580,- 05001511
		$\updownarrow$ 16 cm	1.400,- 05003512 (200 g)	630,- 05001512
Alta 	Salt-cellar Salero Saliera	Salière Zoutstrooier	660,- 05003560 (75 g)	350,- 05001560
	Pepper-box Pimentero Pepaiola	Poivrier Peperstrooier	660,- 05003561 (75 g)	350,- 05001561
	Stand Soporto Relat. piedi.	Support Houder	570,- 05003562 (90 g)	270,- 05001562
	Cocktailstick Brocheta de cóctel Forchettina per cocktail	Broche à cocktail Cocktailprikker	42,- 05003099 (5 g)	31,- 05001099
	Box Bote Contenitore	Boîte Houder	530,- 05003563 (65 g)	300,- 05001563

Table accessories   Accessoires de table   Servicios de mesa   Tafelaccessoires   Accessori da tavola Gift items   Cadeaux   Artículos-regalo   Geschenken   Articoli da regalo		925 Sterling Silver EURO	90 silver plated EURO
	Toast server tray Plateau pour serveur de toast Bandeja para soporte de tostada Tablet voor toasthouder Vassoio per toast 21 x 17 cm	-	520,- 10001524
	Jam server tray Plateau pour confiturier Bandeja para botes de confitura Tablet voor confituurpotten Vassoio per marmellata 31 x 21 cm	-	800,- 10001525
	Toast server Serveur pour toast Soporte de tostada Toasthouder Sostegno per toast (without tray   sans plateau   sin bandeja z. tablet   senza vassoio)	-	325,- 50801111
	Butter dish with silver-plated lid Beurrier avec couvercle argenté Mantequera con tapadera plateada Botervlootje met verzilverd deksel Burriera con coperchio in lega, $\downarrow$ 3 cm	-	351,- 50801104
	Jam server with silver-plated lid Confiturier avec couvercle argenté Bote de confitura con tapadera plateada Confituurpot met verzilverd deksel Barattolo da marmellata con coperchio, $\downarrow$ 5,8 cm	-	385,- 50801105
	Jam server with silver-plated lid Confiturier avec couvercle argenté Bote de confitura con tapadera plateada Confituurpot met verzilverd deksel Barattolo da marmellata con coperchio, $\downarrow$ 8,8 cm	-	398,- 50801106
	Sugar bar   Bar à sucre   Barra para azúcar Suikerbar   Barattolo di zuccheriera 28 x 7,5 cm, $\downarrow$ 6 cm	2.200,- 50803003	1.020,- 50801003
	Sugar spoon   Cuiller à sucre   Cuchara azúcar Suikerlepeltje   Cucchiaino di zuccheriera	116,- 05003023	58,- 05002023
	Sugar bar cover 50801002 210,-		
	Saltbar   Bar à sel   Bar para sal   Zout bar   Saliera 19 x 6 cm, $\downarrow$ 4,5 cm	1.040,- 50803010	560,- 50801001
	Salt spoon   Cuiller à sel   Cuchara sal Zoutlepeltje   Cucchiaino sale Riva	123,- 06403074	54,- 06402074
Spaten (Image)	123,- 02003074	54,- 02002074	
City	123,- 03003074	54,- 03001074	
Salt bar cover 50801302 189,-			

Table accessories | Accessoires de table | Servicios de mesa | Tafelaccessoires | Accessori da tavola  
 Gift items | Cadeaux | Artículos-regalo | Geschenken | Articoli da regalo

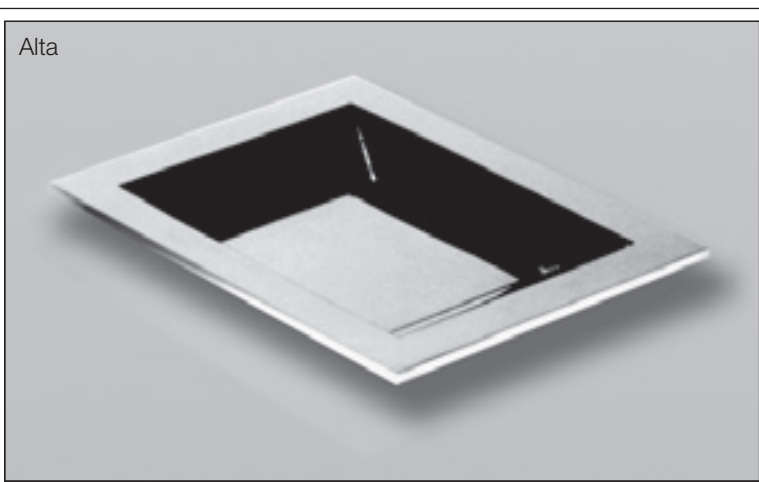
90  
 silver  
 plated  
 EURO



Bread-basket, large  
 Corbeille à pain, grand  
 Cesta para pan, grande  
 Broodmand, groot  
 Cestino pane, grande

Ø 20,0 cm

390,-  
 50801021

Bread-basket, small  
 Corbeille à pain, petit  
 Cesta para pan, pequeño  
 Broodmand, klein  
 Cestino pane, piccolo

Ø 14,5 cm

372,-  
 50801020



Bread platter, large  
 Planche à pain, grande  
 Bandeja para pan, grande  
 Broodplank, groot  
 Vassoio portapane, grande

40,0 x 12,0 cm

520,-  
 50801022

\*without fig. | sans photo | sin ilustración | z. afb. | senza fig.

Bread platter, small  
 Planche à pain, petite  
 Bandeja para pan, pequeña  
 Broodplank, klein  
 Vassoio portapane, piccolo

24,0 x 12,0 cm

329,-  
 50801023



Butter dish with glass insert  
 Beurrier avec insert en verre  
 Tarro para mantequilla con apliques de cristal  
 Boterhouder met glazen afwerking  
 Portaburro con inserto di vetro

Ø 8,0 cm

368,-  
 50801024

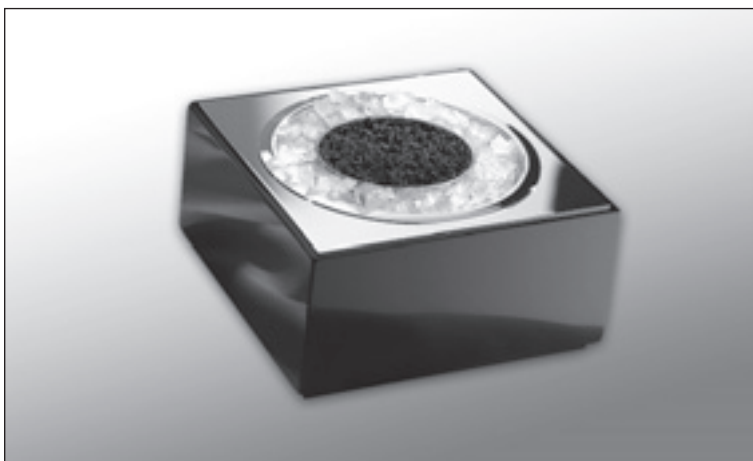

Caviar box  
 Boîte à caviar  
 Tarro para caviar  
 Kaviaardoosje  
 Scatola portacaviale

18,0 x 18,0 cm

Ø 13,5 cm

930,-  
 50801034





Table accessories   Accessoires de table   Servicios de mesa   Tafelaccessoires   Accessori da tavola Gift items   Cadeaux   Artículos-regalo   Geschenken   Articoli da regalo		925 Sterling Silver EURO	90 silver plated EURO
	Covered egg cup + salt shaker Coquetier avec chloche + salière Huevera con tapa y salero Eierdopje m. deksel + zoutstrooier Portauovo con coperchio + saliera	2.100,- 50803005	-
	Pastry tongs Pince à gâteaux Pinzaz pastel Gebaktang Pinza per dolci		150
	Spaten	410,- 02003105	115,- 02002105
	Alt-Kopenhagen	410,- 04003105	115,- 04002105
	Ostfriesen	410,- 01003105	115,- 01002105
	Pastry stand Porte-Petits-Four Etagère Etagere Alzata	14,5 cm	- 490,- 50801019
	Cake stand, large Serviteur, grand Torre para platos, grande Borderetagère, groot Alzata per piatti, grande Plates   Assiettes   Platos   Borden   Piatti ≤ 26,0 cm	49,0 cm 30,0 cm	- 1.270,- 50801110
	Cake stand, middle Serviteur, moyen Torre para platos, media Borderetagère, middelgroot Alzata per piatti, media Plates   Assiettes   Platos   Borden   Piatti ≤ 19,0 cm	38,0 cm 23,0 cm	- 970,- 50801109
	Cake stand, small Serviteur, petit Torre para platos, pequeña Bordenetagère, klein Alzata per piatti, piccola Plates   Assiettes   Platos   Borden   Piatti ≤ 16,0 cm	32,0 cm 19,0 cm	- 870,- 50801009

Table accessories   Accessoires de table   Servicios de mesa   Tafelaccessoires   Accessori da tavola Gift items   Cadeaux   Artículos-regalo   Geschenken   Articoli da regalo		👑 925 Sterling Silver EURO	90 silver plated EURO
<p>Leon</p> 	<p>Salt mill Moulin à sel Molinillo de sal Zoutmolen Macina sale</p> <p>Pepper mill Moulin à poivre Molnillo de pimienta Pepermolen Papaiola</p> <p>Vinegar/Oil bottle Vinaigre/Huile bouteille Vinagre/Aceite botella Azijn-/Olie fles Aceto/Olio bottiglia</p>	<p>17,5 cm</p> <p>17,5 cm</p> <p>0,15 l, 17,5 cm</p> <p>3.300,- 17103563</p> <p>3.300,- 17103564</p> <p>562,- 17103562</p>	<p>1.960,- 17101563 (340 g)</p> <p>1.960,- 17101564 (340 g)</p> <p>395,- 17101562 (50 g)</p>
<p>Leon</p> 	<p>Salt-cellar Salière Salero Zout strooier Saliera</p> <p>Pepper-box Poivrier Pimentero Peperstrooier Pepaiola</p>	<p>7,5 cm</p> <p>7,5 cm</p> <p>880,- 17103560 (80 g)</p> <p>880,- 17103561 (80 g)</p>	<p>600,- 17101560</p> <p>600,- 17101561</p>
<p>Leon</p> 	<p>Tumbler Gobelet Vaso Beker Bicchiere</p> <p>Vase Vase Florero Vaas Vaso</p> <p>Water pitcher Aiguière Jarra d'agua Waterkan Caraffa</p>	<p>0,22 l, 8,0 cm</p> <p>1,36 l, 18,7 cm</p> <p>0,86 l, 28,5 cm</p> <p>1.410,- 17103583</p> <p>5.600,- 17103551</p> <p>3.760,- 17103580</p>	<p>764,- 17101583 (175 g)</p> <p>1.550,- 17101551 (580 g)</p> <p>1.460,- 17101580 (590 g)</p>
	<p>Penguin jugs Carafes pingouins Jarras de pingüino Pinguinkannen Bricchi Pinguino</p> <p>large   grand grande   groot   grande</p> <p>small   petit pequeño   klein   piccolo</p>	<p>1,3 l</p> <p>0,5 l</p> <p>4.160,- 17303580</p> <p>2.470,- 17303581</p>	<p>1.670,- 17301580 (700 g)</p> <p>1.200,- 17301581 (365 g)</p>

Table accessories   Accessoires de table   Servicios de mesa   Tafelaccessoires   Accessori da tavola Gift items   Cadeaux   Artículos-regalo   Geschenken   Articoli da regalo			 925 Sterling Silver EURO	90 silver plated EURO
<p>Sphinx</p> 	<p>Chocolate pot Chocolatière Chocolatera Chocoladekan Cioccolatiera</p> <p>0,5 l, Ø 8,5 cm, <math>\updownarrow</math> 11,6 cm</p>	<p>6.840,- 06903508 (660 g)</p>	<p>3.360,- 06901508</p>	
<p>Sphinx</p> 	<p>Hot beverage pitcher Aigüière pour boisson chaude Bebida caliente Hete dranken kan Brocca per bevanda calda</p> <p>0,5 l, Ø 8,5 cm, <math>\updownarrow</math> 11,6 cm</p>	<p>6.050,- 06903509 (575 g)</p>	<p>3.100,- 06901509</p>	
<p>Sphinx</p> 	<p>Mocha Pot Cafetière Cafetera de moca Moccakan Caffettiera</p> <p>0,5 l, Ø 8,5 cm, <math>\updownarrow</math> 11,6 cm</p>	<p>6.200,- 06903507 (560 g)</p>	<p>3.080,- 06901507</p>	
<p>Sphinx</p> 	<p>Water pitcher Pot Jarra Kan Brocca</p> <p>1,0 l, Ø 10,5 cm, <math>\updownarrow</math> 13,8 cm</p>	<p>5.710,- 06903580 (830 g)</p>	<p>3.310,- 06901580</p>	

Table accessories | Accessoires de table | Servicios de mesa | Tafelaccessoires | Accessori da tavola  
 Gift items | Cadeaux | Artículos-regalo | Geschenken | Articoli da regalo

925

Sterling  
 Silver  
 EURO

90  
 silver  
 plated  
 EURO

Sphinx



Wine tumbler  
 Gobelet à vin  
 Vaso de vino  
 Wijnbeker  
 Bicchiere da vino  
 Ø 7,0 cm, 7,2 cm

Water tumbler  
 Gobelet à eau  
 Vaso de agua  
 Waterbeker  
 Bicchiere per l'acqua  
 Ø 7,5 cm, 9,5 cm

Vodka beaker  
 Coupe à vodka  
 Vaso para vodka  
 Wodkabeker | Coupe à vodka  
 Bicchiere per vodka  
 Ø 4,7 cm, 5,0 cm

1.230,-  
 06903582  
 (ca. 165 g)

1.300,-  
 06903583  
 (ca. 200 g)

710,-  
 06903581  
 (ca. 65 g)

590,-  
 06901582

600,-  
 06901583

520,-  
 06901581

Sphinx

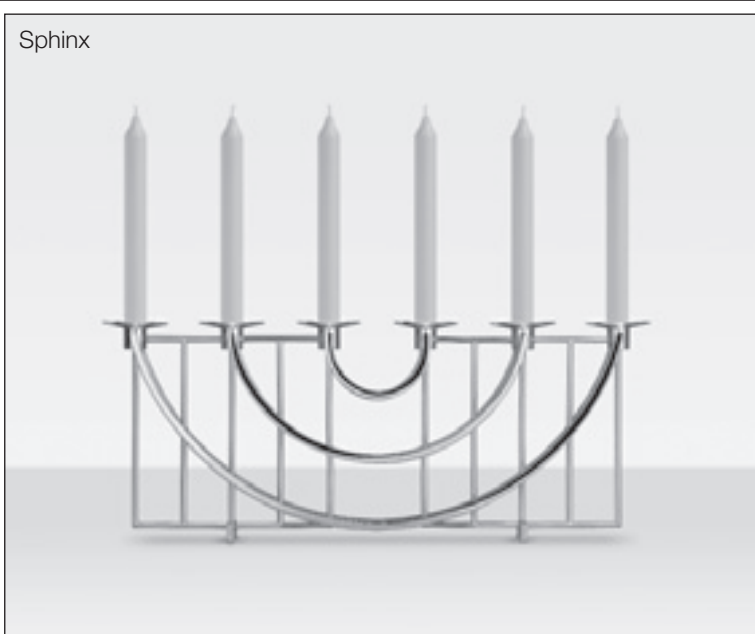

Candelabra, 6 branches  
 Chandelier, 6-branches  
 Candelabro, 6 buijas  
 Kandelaar, 6-armig  
 Candeliere, 6-luci  
 23,5 cm, 60,0 cm

12.760,-  
 06903513  
 (ca. 2.450 g)

4.980,-  
 06901513

Sphinx

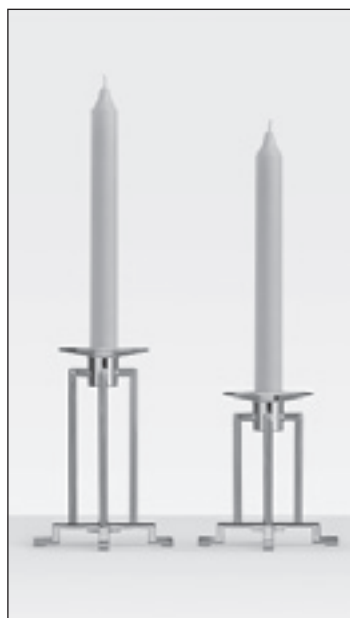

Candelabra, 3 branches  
 Chandelier, 3-branches  
 Candelabro, 3 buijas  
 Kandelaar, 3-armig  
 Candeliere, 3-luci  
 20,0 cm

Candlestick | Chandelier  
 Candelabro | Kandelaar  
 Candeliere  
 16,0 cm

Candlestick | Chandelier  
 Candelabro | Kandelaar  
 Candeliere  
 12,0 cm

4.560,-  
 06903514  
 (810 g)

1.780,-  
 06903512  
 (310 g)

1.730,-  
 06903511  
 (275 g)

2.120,-  
 06901514

950,-  
 06901512

940,-  
 06901511



Grande Composition  
 (a pair of candleholders | une paire de chandeliers  
 Par de candeleros | een paar kandelaars  
 Coppia di candelabri)

Price per candleholder  
 Prix par chandelier  
 Precio por candelero  
 Prijs per kandelaar  
 Prezzo cadauno

3.380,-  
 17603510  
 (ca. 540 g)

1.450,-  
 17601510

Dimensions | Dimensions | Medida  
 afmetingen | Misure 36 x 8,6 x 15,6 cm

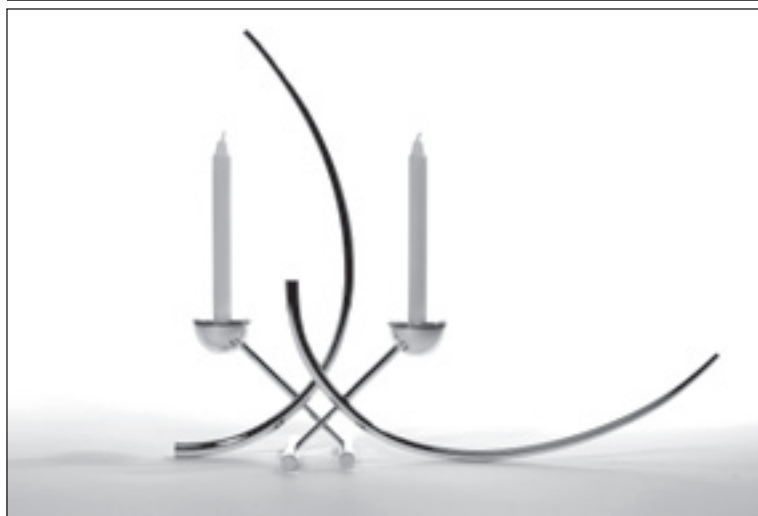

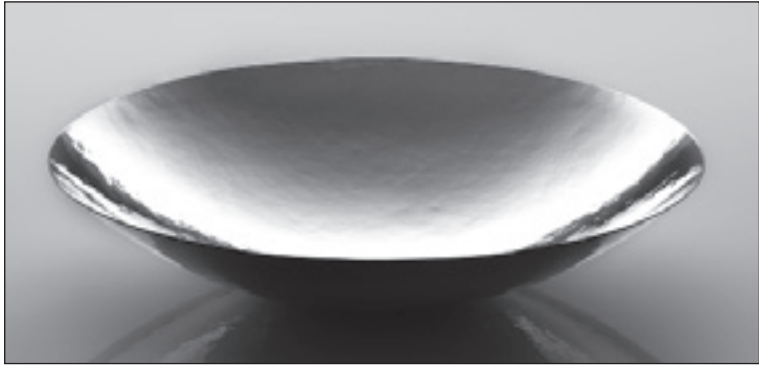





Table accessories   Accessoires de table   Servicios de mesa   Tafelaccessoires   Accessori da tavola Gift items   Cadeaux   Artículos-regalo   Geschenken   Articoli da regalo			 925 Sterling Silver EURO	90 silver plated EURO
	Bowl Hermitage Jatte Hermitage	Ø 22,0 cm, $\downarrow$ 4,5 cm	2.020,- 07003540 (328 g)	920,- 07001540
	Bowl   Jatte   Bol   Schaal   Coppa  Jan von Borstel polished	Ø 47 cm	27.750,- 17203045 (5.700 g)	-
	Jan von Borstel satin finished	Ø 47 cm	27.750,- 17203046 (5.700 g)	-
	Small bowl, oval Petite jatte, ovale Bol, pequeño, oval Schaal, ovaal Coppetta, ovale	24 x 13 cm	930,- 51103001	-
	Bowl, perforated Jatte, perforée Bol, perforado Schaal, geperforeerd Coppa, perforata	Ø 15 cm	1.980,- 50803028	-
	Bowl, perforated Jatte, perforée Bol, perforado Schaal, geperforeerd Coppa, perforata	Ø 25 cm	5.110,- 50803029	-
Martelé	Bowl   Jatte Bol   Schaal   Coppa	Ø 10,0 cm, $\downarrow$ 5,0 cm	439,- 06303540 (50 g)	243,- 06301540
	Bowl   Jatte Bol   Schaal   Coppa	Ø 12,0 cm, $\downarrow$ 6,0 cm	501,- 06303541 (80 g)	265,- 06301541

Neue Form



Coffee pot  
 Cafetière  
 Cafetera  
 Koffiekan  
 Caffettiera

1,5 l, Ø 15 cm, 14,5 cm

7.550,-  
 10003501  
 (700 g)

Neue Form



Tea pot  
 Théière  
 Tetera  
 Theepot  
 Teiera

1,0 l, Ø 16 cm, 11,5 cm

7.550,-  
 10003502  
 (630 g)

Neue Form



Creamer  
 Crémier  
 Jarrita crema  
 Melkkannetje  
 Bricchetto

2.390,-  
 10003503  
 (190 g)

Sugar bowl, with cover  
 Sucrier, avec couvercle  
 Azucarera, con tapa  
 Suikerpot met deksel  
 Zuccheriera con coperchio

1.900,-  
 10003504  
 (190 g)

Tray  
 Plateau  
 Bandeja  
 Blad voor Roomstel  
 Vassoio

28 x 19,5 cm

2.630,-  
 10003523  
 (480 g)

Neue Form



Tray  
 Plateau  
 Bandeja  
 Serveerblad  
 Vassoio

42 x 31 cm

8.070,-  
 10003526  
 (1.500 g)

Alt-Kopenhagen

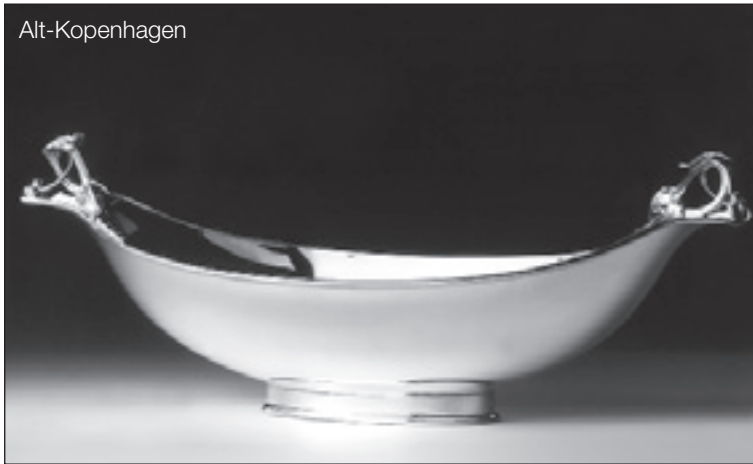

Bowl  
 Jatte  
 Bol  
 Schaal  
 Coppa

39 x 17 cm

5.720,-  
 04003541  
 (700 g)

Alt-Kopenhagen



Basket, with handle  
 Panier à anses  
 Cesta, con asas  
 Hengselmand  
 Coppa con manico

29,5 x 17 cm, 23,5 cm

5.870,-  
 04003540  
 (710 g)

Alt-Kopenhagen



Alt-Kopenhagen



Candlestick | Chandelier  
 Candelabro | Kandelaar, 1-armig | Candeliera

Ø 4 cm, 6 cm

580,-  
 04003509

Box for toothpicks | Boîte de cure-dents  
 Palillero | Tandestokerhouder  
 Scatola per stuzzicadenti

21,5 cm

480,-  
 04003563

Candelabra, 2 branches  
 Chandelier, 2 branches  
 Candelabro, 2 bujías  
 Kandelaar, 2-armig  
 Candeliera, 2 luci

7.740,-  
 04003510  
 (600 g)

Bottle cap  
 Bouchon  
 Tapón  
 Flessenkurk  
 Tappo per bottiglia

480,-  
 04003562

Alt-Kopenhagen



Candelabra, 5 branches  
 Chandelier, 5 branches  
 Candelabro, 5 bujías  
 Kandelaar, 5-armig  
 Candeliera, 5 luci

21 cm

13.400,-  
 04003511  
 (1.090 g)

Alt-Augsburg



Coffee pot  
 Cafetière  
 Cafetera  
 Koffiekan  
 Caffettiera

1,5 l, Ø 15 cm, 22 cm

6.320,-  
 10103501  
 (670 g)

Alt-Augsburg



Tea pot  
 Théière  
 Tetera  
 Theepot  
 Teiera

1,3 l, Ø 15 cm, 19 cm

6.320,-  
 10103502  
 (570 g)

Alt-Augsburg



Creamer, inside gold  
 Crémier, à l'intérieur doré  
 Jarrita crema, con interior dorado  
 Melkkannetje, binnen verguld  
 Bricchetto con doratura interna

2.640,-  
 10103503  
 (170 g)

Sugar bowl, with cover, inside gold  
 Sucrier, avec couvercle, à l'intérieur doré  
 Azucarera, con tapa, con interior dorado  
 Suikerpot met Deksel, binnen verguld  
 Zuccheriera con coperchio e doratura interna

2.960,-  
 10103504  
 (190 g)

Tray  
 Plateau  
 Bandeja  
 Blad voor Roomstel  
 Vassoio

26 x 18 cm

3.220,-  
 10103523  
 (420 g)

Alt-Augsburg



Tray  
 Plateau  
 Bandeja  
 Serveerblad  
 Vassoio

42 x 31 cm

8.280,-  
 10103526  
 (1.500 g)

Alt-Augsburg



Jug, inside gold Pot, à l'intérieur doré Jarra, con interior dorado Kan verguld Brocca con doratura interna	1,5 l, Ø 14,5 cm, 17 cm	5.560,- 10103507 (490 g)
Tumbler, inside gold Gobelet, à l'intérieur doré Vaso, con interior dorado Beker, binnen verguld Bicchiere con doratura interna	9,5 cm	1.400,- 10103550 (135 g)
Bottle cap Bouchon Tapón Flessenkurk Tappo per bottiglia		340,- 10103562

Alt-Augsburg



Salt cellar Salière Salero Zoutstrooier Saliera	4,5 cm	590,- 10103560 (28 g)
Pepper pot Poivrier Pimentero Peperstrooier Pepaiola	4,5 cm	590,- 10103561 (28 g)
Vase Vase Florero Vaas Vaso	12 cm	1.320,- 10103551 (130 g)

Alt-Augsburg



Bowl Jatte carrée Bol Schaal, vierkant Coppa	23 x 23 cm	2.440,- 10103541 (470 g)
Bowl Jatte carrée Bol Schaal, vierkant Coppa	14 x 14 cm	1.440,- 10103540 (130 g)
Bowl Jatte rectangulaire Bol Schaal, rechthoekig Coppa	21,5 x 15,5 cm	2.080,- 10103542 (300 g)

Alt-Augsburg



Candlestick  
 Chandelier, 1 branches  
 Candelabro, 1 bujía  
 Kandelaar, 1-armig  
 Candeliera, 1 luce

19 cm

1.520,-  
 10103510  
 (120 g)

Alt-Augsburg



Candelabra, 3 branches  
 Chandelier, 3 branches  
 Candelabro, 3 bujías  
 Kandelaar, 3-armig  
 Candeliera, 3 luci

27 cm

3.840,-  
 10103511  
 (350 g)

Candelabra, 5 branches  
 Chandelier, 5 branches  
 Candelabro, 5 bujías  
 Kandelaar, 5-armig  
 Candeliera, 5 luci

27 cm

5.250,-  
 10103512  
 (460 g)

Alt-Augsburg



Candelabra, 7 branches  
 Chandelier, 7 branches  
 Candelabro, 7 bujías  
 Kandelaar, 7-armig  
 Candeliera, 7 luci

56 cm

22.400,-  
 10103513  
 (3.030 g)

Empire



Candlestick  
 Chandelier  
 Candelabro  
 Kandelaar  
 Candeliere

12 cm

860,-  
 10403511  
 (98 g)

Candlestick  
 Chandelier  
 Candelabro  
 Kandelaar  
 Candeliere

15,5 cm

1.055,-  
 10403512  
 (116 g)

Empire



Candelabra, 9 branches  
 Chandelier, 9 branches  
 Candelabro, 9 bujías  
 Kandelaar, 9-armig  
 Candeliere, 9 braccia

74 cm

35.500,-  
 10403510  
 (4.200 g)

Kordelrand



Jug Pot Jarra Kan Brocca	1,2 l, Ø 14 cm, 16 cm	4.390,- 10203507 (520 g)
Tumbler, inside gold Gobelet, à l'intérieur doré Vaso, con interior dorado Beker, binnen verguld Bicchieri con doratura interna	Ø 7,5 cm, 8,5 cm	1.260,- 10203550 (170 g)

Kordelrand



Vase Vase Florero Vaas Vaso	Ø 7 cm, 8 cm	840,- 10203551 (85 g)
Vase Vase Florero Vaas Vaso	Ø 14 cm, 16 cm	2.900,- 10203552 (520 g)

Kordelrand



Bowl Jatte Bol Schaal Coppa	Ø 21 cm, 9 cm	3.850,- 10203541 (640 g)
Bowl* Jatte Bol Schaal Coppa	Ø 15 cm, 6 cm	1.820,- 10203540 (310 g)
Bread-basket Corbeille à pain Cesta para pan Broodmand Cestino pane	26,5 x 19,5 cm	2.700,- 10203542 (430 g)

\*without fig. | sans photo | sin ilustración | z. afb. | senza fig.

Kordelrand



Butter dish, with cover Beurrier, avec couvercle Mantequera, con tapa Botervloot met deksel Burriera con coperchio	16,5 x 12,5 cm	2.700,- 10203544 (360 g)
Box, with cover, inside gold Bonbonnière, avec couvercle, à l'intérieur doré Bombonera, con tapa, con interior dorado Bonbonnière met deksel Scatola per caramelle con coperchio e doratura interna	Ø 12 cm, 9 cm	2.880,- 10203543 (250 g)





Crystal bowl with silver cover and silver trimming Ø 14 cm  
 Coupe de cristal avec couvercle d'argent et garniture d'argent  
 Caja con tapa de plata y adornos de plata  
 Schaal van Kristal met Zilver-Deksel en Zilver-Beslag  
 Coppa cristallo con coperchio argento e decorazione in argento

1.170,-  
 50803030  
 (120 g)

-



Caviar bowl with silver cover and silver trimming Ø 17 cm  
 Coupe à caviar avec couvercle d'argent et garniture d'argent  
 Fuente para caviar con tapa de plata y adornos de plata  
 Kaviaarschaal met Zilver-Deksel en Zilver-Beslag  
 Coppa caviale con coperchio argento e decorazione in argento

1.860,-  
 50803031  
 (210 g)

-



Set Sylt Oyster | Set Huître Sylt  
 Juego ostra de Sylt | Set Sylt Oester  
 Set ostrica di Sylt

1.505,-  
 51403,01,3

-

Set Sylt Oyster | Set Huître Sylt  
 Juego ostra de Sylt | Set Sylt Oester  
 Set ostrica di Sylt

- 718,-  
 51432,01,3

(inside gold | à l'intérieur doré | con interior dorado  
 binnen verguld | con doratura interna)

consistant | comprenant | consistiendo en  
 bestaande uit | consiste di:

1 Sylt Oyster | 1 Huître Sylt | 1 Ostra de Sylt  
 1 Sylt Oester | 1 ostrica di Sylt

1 Salt spoon Riva | 1 Cuijler de sel Riva | 1 Cuchara de sal Riva  
 1 Zoutlepel Riva | 1 cucchiaino da sale Riva (👉)

Sea Salt | Sel marin | Sal marina de Sylt | Zeezout Sylt  
 Sale marino di Sylt

Wooden tray | Plateau en bois | Bandeja de madera  
 Houten blad | Vassoio di legno

Booklet | Livret | Folleto | Boekje | Brochure

Gift box | Coffret-cadeau | Estuche | Kist | Astuccio

Service plates and trays | Assiettes et plateaux  
Platos y bandejas | Borden | Piatti e vassoi

925

90

Sterling  
Silver  
EURO

silver  
plated  
EURO

925 90



Tray Bandeja para vasos Vassoio per bicchieri	Plateau Serveerblad			
Alta Ø 40 cm	05003519 05001519	6.190,- (1.623 g)	1.830,-	
Alta Ø 36 cm	05003526 05001526	5.300,- (1.075 g)	1.160,-	
Alt-Spaten Ø 41 cm	01903519 01901519	7.300,- (1.625 g)	1.970,-	
Alt-Spaten Ø 30 cm	01903526 01901526	3.070,- (675 g)	868,-	
Französisch-Perl Ø 30 cm	04603526 04601526	3.210,- (765 g)	752,-	
Alt-Faden Ø 30 cm	04503526 04501526	3.170,- (770 g)	760,-	
Service plate Plato servir Sottopiatto segnaposto	Assiette de présentation Plaatsbord			
Classic-Faden Ø 32,5 cm	05703524 05701524	3.400,- (850 g)	675,-	
Arcade Ø 32,5 cm	05603524 05601524	4.220,- (900 g)	1.070,-	
Alta Ø 30 cm	05003524 05001524	3.130,- (660 g)	764,-	
Alta Ø 32 cm	05003525 05001525	3.300,- (750 g)	990,-	
Alt-Spaten Ø 30 cm	01903524 01901524	2.730,- (620 g)	768,-	
Französisch-Perl Ø 30 cm	04603524 04601524	3.150,- (720 g)	650,-	
Alt-Faden Ø 30 cm	04503524 04501524	2.980,- (700 g)	674,-	
Bottle-coaster Posabotella Sottobottiglia	Sous-bouteille Flesonderzetter			
Classic-Faden Ø 13,5 cm	05703521 05701521	540,- (125 g)	134,-	
Arcade Ø 14,5 cm	05603521 05601521	648,- (150 g)	176,-	
Alta Ø 14,5 cm	05003521 05001521	560,- (115 g)	95,-	
Alt-Spaten Ø 13,5 cm	01903521 01901521	440,- (94 g)	145,-	
Französisch-Perl Ø 13,5 cm	04603521 04601521	490,- (125 g)	124,-	
Alt-Faden Ø 13,5 cm	04503521 04501521	420,- (94 g)	132,-	
Martelé (p. 23)	06301521	-	103,-	
Coaster Posavaso Sottobicchiere	Sous-verre Glasonderzetter			
Classic-Faden Ø 10,5 cm	05703520 05701520	284,- (55 g)	112,-	
Arcade Ø 11,5 cm	05603520 05601520	410,- (58 g)	148,-	
Alta Ø 11,5 cm	05003520 05001520	390,- (77 g)	82,-	
Alt-Spaten Ø 10,5 cm	01903520 01901520	300,- (55 g)	116,-	
Französisch-Perl Ø 10,5 cm	04603520 04601520	280,- (55 g)	104,-	
Alt-Faden Ø 10,5 cm	04503520 04501520	294,- (55 g)	112,-	
Martelé (p. 23)	06301520	-	88,-	

Chess | échecs | el ajedrez | schaak | gli scacchi

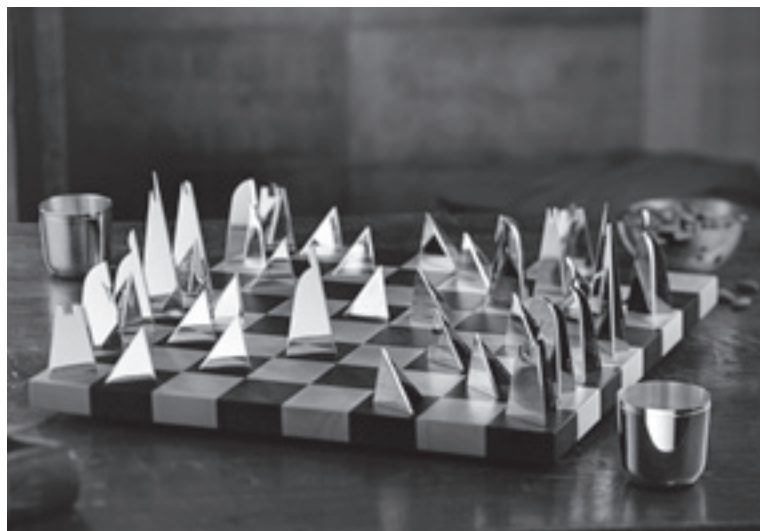

Chess | échecs | el ajedrez | schaak | gli scacchi 19.000,-  
51503.35,1

consistant | comprenant | consistiendo en | bestaande uit | consiste di:

16x Chess piece, 925/000 | 16x Pièce d'échecs, 925/000 | 16x Pieza de ajedrez, 925/000  
16x Schaakstuk, 925/000 | 16x Figura degli scacchi, 925/000

16x Chess piece, 925/000, gilded | 16x Pièce d'échecs, 925/000, doré  
16x Pieza de ajedrez, 925/000, dorada | 16x Schaakstuk, 925/000, verguld  
16x Figura degli scacchi, 925/000, dorato

1x Chessboard maple and wengé | 1x L'échiquier érable et wengé  
1x Tablero de ajedrez arce y wengé | 1x Schaakbord esdoorn en wengé  
1x Scacchiera legno acero e wengé

1x Tumbler, 925/000, inside gold | 1x Gobelet, 925/000, à l'intérieur doré | 1x Vaso, 925/000, con interior dorado | 1x Beker, 925/000, binnen verguld | 1x Bicchiera, 925/000, con doratura interna

1x Tumbler, 925/000, outside gold | 1x Gobelet, 925/000, à l'extérieur doré | 1x Vaso, 925/000, con exterior dorado | 1x Beker, 925/000, buiten verguld | 1x Bicchiera, 925/000, con doratura esterna

1x Leather etui | 1x Etui en cuir | 1x Caja de cuero | 1x Etui in leer | 1x Astuccio in pelle

Chess pieces also available in platinum (Pt960) and gold (Au999). Price upon request.  
Pièces d'échecs également disponibles en platine (Pt960) et or (Au999). Prix sur demande.  
Piezas de ajedrez también disponible en platino (Pt960) y oro (Au999). Precio bajo petición.  
Schaakstukken ook verkrijgbaar in platina (Pt960) en goud (Au999). Prijs op aanvraag.  
Pezzi degli scacchi disponibili anche in platino (Pt960) e oro (Au999). Prezzo su richiesta.



Chess pieces | Pièces d'échecs  
Piezas de ajedrez | Schaakstukken  
Pezzo degli scacchi

♔ 925 Sterling Silver EURO	♔ 925 Sterling Silver gilded EURO
----------------------------------	--

King   Roi   Rey   Koning   Re ♗ 12,5 cm, ♔→4 cm	891,- 51503001	1.020,- 51543001
Queen   Dame   Reina   Dame   Regina ♗ 10,2 cm, ♔→4 cm	734,- 51503002	855,- 51543002
Bishop   Fou   Alfil   Loper   Alfieri ♗ 9,0 cm, ♔→4 cm	659,- 51503004	771,- 51543004
Knight   Cavalier   Caballo   Paard   Cavallo ♗ 7,9 cm, ♔→4 cm	733,- 51503005	843,- 51543005
Rook   Tour   Torre   Toren   Torre ♗ 5,8 cm, ♔→4 cm	597,- 51503003	694,- 51543003
Pawn   Pion   Peón   Pion   Pedone ♗ 4,4 cm, ♔→4 cm	364,- 51503006	418,- 51543006

Chess pieces also available in platinum (Pt960) and gold (Au999). Price upon request.

Pièces d'échecs également disponibles en platine (Pt960) et or (Au999). Prix sur demande.

Piezas de ajedrez también disponible en platino (Pt960) y oro (Au999). Precio bajo petición.

Schaakstukken ook verkrijgbaar in platina (Pt960) en goud (Au999). Prijs op aanvraag.

Pezzi degli scacchi disponibili anche in platino (Pt960) e oro (Au999). Prezzo su richiesta.

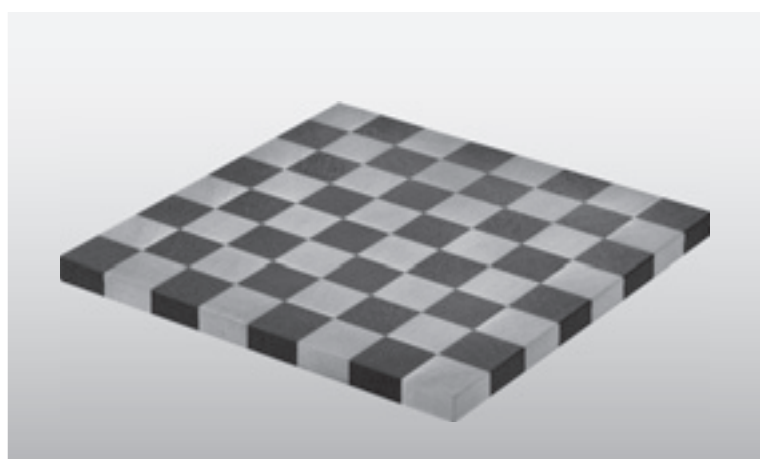

Chessboard 650,-  
L'échiquier 51508001  
Tablero de ajedrez  
Schaakbord  
Scacchiera

Handcrafted from maple and wengé  
Fait à la main d'érable et de wengé  
Hecho a mano de arce y wengue  
Handgemaakt uit hoorn en wengé  
Fatto a mano di acero e wengé

Dimensions ♔→44 cm  
Dimensions ♗→44 cm  
Medida ♗ 3 cm  
afmetingen  
Misure



Snowman   Bonhomme de neige Muñeco de nieve   Sneeuwman   Pupazzo de neve	–	39,– 51201022
Advent wreath   Couronne de l'advent Corona di adventio   Adventskrans Corona d'avento	–	39,– 51201023
X-mas tree 1   Arbre de noel 1   Arbol de navidad 1 Kerstboom 1   Albero di Natale 1	–	39,– 51201024
X-mas tree 2   Arbre de noel 2   Arbol de navidad 2 Kerstboom 2   Albero di Natale 2*	–	39,– 51201032
Aviary   Volière Nido de pajaros   Vogelhuis   Uccelliera	–	39,– 51201025
Sheaf   Gerbe Govilla   Korengarf   Covone*	–	39,– 51201026
Ice cristal 1   Cristal à glace 1   Cristal de hielo 1 Ijskristal 1   Cristallo di ghiaccio 1*	–	39,– 51201027
Ice cristal 2   Cristal à glace 2   Cristal de hielo 2 Ijskristal 2   Cristallo di ghiaccio 2*	–	39,– 51201033
Pair of dwarfs 1   Pair de gnome 1   Pareja enanos 1 Kabouterpaar 1   Paio di gnomi 1*	–	39,– 51201028
Pair of dwarfs 2   Pair de gnome 2   Pareja enanos 2 Kabouterpaar 2   Paio di gnomi 2*	–	39,– 51201029
Lady with heart   Dame avec coeur Señora con corazón   Dame met hart Signora con cuore*	–	39,– 51201034
Easter Ornaments   Decoration de paques Adornos arbol de pascua   Paasversiering Collezione di pasqua		
2 Small chicken   2 Poussin   2 Pájari 2 Paaskuiken   2 Pulcini*	–	39,– 51201030
4 Small chicken   4 Poussin   4 Pájari 4 Paaskuiken   4 Pulcini*	–	39,– 51201031

\*without fig. | sans photo | sin ilustración | z. afb. | senza fig.



Table candle stick   Bougeoir de table Candelabro de mesa   Kaarshouder v. de tafel Candeliere da tavola		
X-mas tree   Arbre de noel   Arbol de navidad Kerstboom   Albero di Natale	307,– 51203003	–
Moon   Lune Luna   Maan   Luna	305,– 51203001	–
Angel   Ange Angel   Engel   Angelo	303,– 51203002	–
Dove   Pigeon Paloma   Duif   Colomba	305,– 51203006	–
Bell   Cloche   Campanilla Klok   Campana	305,– 51203004	–
Star   Etoile Estella   Ster   Stella*	307,– 51203005	–
Heart   Coeur Corazón   Hart   Cuore	303,– 51203007	–

\*without fig. | sans photo | sin ilustración | z. afb. | senza fig.



Coats of arms | Armes | Escudos | Wapens | Armi



Mercedes-Benz



Prices on request | Prix sur demande | Consultar precios | Prijzen op aanvraag | Prezzo su richiesta

Types | Lettres | Tipos de letra | Lettertypen | Tipi di carattere

*Englische Schreibrschrift*

Antiqua

Blockschrift

Fraktur

Engraving signature | Nom gravé  
Grabados de un nombre | Gegraveerde naam | Nome inciso

Engraving per character depending on size and volume of order (at least 3 letters)  
1 lettre en texte courant selon taille et quantité (au moins 3 lettres)  
Cada letra de texto corrido, en función del tamaño y del volumen del encargo (al menos 3 letras)  
1 letter lopende tekst telkens naar grootte en orderomvang (minimaal 3 letters)  
Incisione per carattere a seconda delle dimensioni e del volume dell'ordine (almeno 3 lettere)

from | à partir | desde  
vanaf | da

EURO 17,-

EURO 3,-

Monograms | Monogrammes | Monogramas | Monogrammen | Monogrammi



1



2



3



4



5



6

1 letter EURO 10,-  
2 letters EURO 13,-



7



8



9



10



11



12

Customised knife blades | Lames de couteau personnalisées | Hojas de cuchillo personalizadas  
Geïndividualiseerde mesbladen | Lame di coltello personalizzate

Attention to detail: With a new technology, Robbe & Berking offers you the possibility to individualise menu and steak knife blades – e.g. with the logo of your restaurant, your family crest, facsimile or the silhouette of your yacht. The Robbe & Berking logo is positioned on the reverse of the blade. We offer this option for Martelé, Riva and Belvedere blades in shiny and “Frozen Black” finishes. Make your knives unique.

Attention au détail: Grâce à une nouvelle technologie, Robbe & Berking vous offre la possibilité d’individualiser les lames des couteaux à menu et à steak – par exemple avec le logo de votre restaurant, le blason de votre famille, un fac-similé ou la silhouette de votre yacht. Le logo de Robbe & Berking est placé au dos de la lame. Nous proposons cette option pour les lames Martelé, Riva et Belvedere en finition brillante et «Frozen Black». Créez vos couteaux uniques.

Laser Cut examples | Laser Cut exemples | Laser Cut ejemplos | Laser Cut voorbeelden | Laser Cut esempi



Marble cut examples | Marble cut exemples | Marble cut ejemplos | Marble cut voorbeelden | Marble cut esempi



**Laser Cut Individualizations | Personnalizations par Laser Cut | Individualizaciones Laser Cut  
Laser Cut Individualisations | Individualizzazioni con Laser Cut**

If the desired motif is available as a vector file.  
Si le motif souhaité est disponible sous forme vectoriel.  
Si el motivo deseado está disponible como archivo vectorial.  
Indien het gewenste motief als vectorbestand beschikbaar is.  
Se il motivo desiderato è disponibile come file vettoriale.

EURO 20,-

Without vector file the price is on request. | Sans fichier vectoriel, le prix est sur demande. | Sin archivo vectorial el precio es a petición.  
Zonder vectorbestand is de prijs op aanvraag. | Senza file vettoriale il prezzo è su richiesta.

(The Robbe & Berking lettering is on the reverse of the knife. | L’inscription Robbe & Berking se trouve au dos du couteau. La inscripción Robbe & Berking está en el reverso del cuchillo. | De Robbe & Berking letters staan op de achterkant van het mes. La scritta Robbe & Berking si trova sul retro del coltello.)

**Marble Cut Individualisations | Personnalizations Marble Cut | Individualizaciones Marble Cut  
Marble Cut Individualisations | Individualizzazioni Marble Cut**

Available in the Martelé, Belvedere and Riva collections. | Disponible dans les collections Martelé, Belvedere et Riva. | Disponible en las colecciones Martelé, Belvedere y Riva. | Verkrijgbaar in de collecties Martelé, Belvedere en Riva. | Disponibile nelle collezioni Martelé, Belvedere e Riva.

Marble Cut laser engraving  
Marble Cut gravure au laser  
Grabado por láser Marble Cut  
Marble Cut lasergravure  
Incisione laser Marble cut

EURO 24,- per knife (plus knife price)  
EURO 24,- par couteau (prix du couteau en plus)  
EURO 24,- por cuchillo (más el precio del cuchillo)  
EURO 24,- per mes (plus mesprijs)  
EURO 24,- per coltello (più il prezzo del coltello)

Robbe & Berking cutlery is manufactured through all quality groups out of the respectively best materials. The sophisticated and detailed manufacturing quality is unsurpassed worldwide.

 925 Sterling Silver

925 sterling silver is the internationally-acknowledged and most valuable silver alloy. It consists to 92.5 % of fine silver and to 7.5 % of fine copper.

 150 g massive silver plated

Cutlery is subjected to far greater stresses than tableware. The 150 g solid silver plating on cutlery is a development from the Robbe & Berking laboratory which has now become widespread. It is characterised by a silver coating which is two thirds thicker than the still widely-used 90 g silver plating. Instead of 90 g of fine silver, 150 g are applied to a surface of 24 dm<sup>2</sup>. This coating is the prerequisite for an extremely high wear resistance and a long lifetime.

**ROBBE & BERKING**  
— S I L B E R —

Robbe & Berking Silbermanufaktur seit 1874 GmbH & Co. KG  
Zur Bleiche 47 · D-24941 Flensburg · Germany  
Telephone +49 (0) 461 / 90 30 60 · Fax +49 (0) 461 / 90 30 6-22

[info@robbeberking.com](mailto:info@robbeberking.com)  
[www.robbeberking.com](http://www.robbeberking.com)

**ROBBE & BERKING**  
— SILBER —

WWW.ROBBEBERKING.COM